

QUICK SELECTION / Selezione veloce

input speed (n_1) = 1400 min⁻¹

Output Speed n_2 [min ⁻¹]	Ratio i	Motor power P_{1M} [kW]	Output torque M_{2M} [Nm]	Service factor f.s.	Nominal power P_{1R} [kW]	Nominal torque M_{2R} [Nm]	Available B5 motor flanges				Available B14 motor flanges			Dynamic efficiency RD	Tooth Module [mm]	Ratios code
							-B	-C	-D	-E	-Q	-R	-T			
							63	71	80	90	71	80	90			
16.8	83.2	1.5	587	1.1	1.7	660					C			69	3.5	01
13.9	100.5	1.5	699	0.8	1.3	594					C			68	2.9	02
10.6	132	1.1	634	0.9	0.95	550					C			64	2.2	03
8.0	176	0.75	666	1.2	0.90	803	B				C			74	4.7	04
6.7	208	0.75	766	0.9	0.65	660	B				C			72	4.0	05
5.7	245	0.55	634	1.0	0.57	660	B				C			69	3.5	06
4.7	296	0.55	755	0.8	0.43	594	B				C			68	2.9	07
4.2	334	0.55	865	0.8	0.42	660	B				C			69	3.5	08
3.5	403	0.37	692	0.9	0.32	594	B				C			68	2.9	09
2.6	529	0.25	577	1.0	0.24	550	B				C			64	2.2	10
2.2	624	0.25	628	0.8	0.21	528	B				C			59	1.9	11

Motor Flanges Available
Flange Motore Disponibili

B) Supplied with Reduction Bushing
Fornito con Bussola di Riduzione

B) Available on Request without reduction bushing
Disponibile a Richiesta senza Bussola di Riduzione

C) Motor Flange Holes Position
Posizione Fori Flangia Motore

EN Unit **P10** is supplied without lubricant and equipped with a breather, level and drain plugs. User can add mineral oil keeping existing plugs. Should the user wish to fill it with synthetic oil, it is recommended to replace the existing plugs with a closed plug. Primary reduction unit is supplied with closed plugs and lubricated for life with synthetic oil. See table 1 for lubrication and recommended quantity. In table 2 please see possible radial loads and axial loads on the gearbox.

I Il riduttore tipo **P10** è fornito privo di lubrificazione con tappi di sfiato, livello e scarico olio. L'utente può immettere olio minerale mantenendo i tappi esistenti. Se immetterà olio sintetico, dovrà sostituire i tappi esistenti con altri tipo chiuso. La precoppia è fornita con tappi chiusi e lubrificata a vita con olio sintetico. Tab.1 per oli e quantità consigliati. Tab.2 carichi radiali e assiali applicabili al riduttore.

D Das Getriebe der Baugröße **P10** wird ohne Schmiermittel geliefert. Es ist jedoch mit Einfüllschraube, Überdruckventil und Ablassschraube ausgerüstet. Das benötigte mineralische Öl kann über die Einfüllschraube eingefüllt werden. Sollte synthetisches Öl bevorzugt werden, so ist sind das eingebaute Überdruckventil durch eine geschlossenen Schraube zu ersetzen. Die Stirnradvorstufe ist Lebensdauer geschmiert und wird mit synthetischem Öl geliefert. Die Stirnradvorstufe ist komplett geschlossen ohne Füllschrauben. In Tabelle 1 ist die Schmiermenge und das empfohlene Schmiermittel angegeben. In Tabelle 2 sind die zulässigen Radial- und Axialbelastungen des Getriebes aufgeführt.

F Le réducteur de type **P10** est fourni sans lubrification et avec un bouchon de remplissage, de niveau et d'évacuation de l'huile. L'utilisateur peut y verser de l'huile minérale en conservant les bouchons existants. S'il y versera de l'huile synthétique, il devra substituer les bouchons existants avec d'autres bouchons de type fermé. Le pré couple est fourni lubrifié à vie avec de l'huile synthétique et avec des bouchons fermés. Voir tableau 1 concernant les huiles et les quantités conseillées. Voir tableau 2 concernant les charges radiales et axiales applicables au réducteur

E El reductor tamaño **P10** se suministra sin lubricante, provisto de tapones de respiración, nivel y descarga de aceite. El usuario puede utilizar aceite mineral, manteniendo los tapones existentes. Si prefiere utilizar aceite sintético deberá sustituir los tapones existentes por tapones ciegos. La prerreducción se suministra con tapones ciegos, lubricado de por vida con aceite sintético. Ver tabla 1, para cantidades y aceites recomendados. En la tabla 2, se encuentran las cargas radiales y axiales admitidas por el reductor.

B3	B6	B7	B8	V5	V6
2.0/0.14LT	1.35/0.14 LT	1.35/0.14 LT	2.0/0.14 LT	2.0/0.14 LT	2.0/0.14 LT

AGIP Blasias 460

For all details on lubrication and plugs check our website **tab. 1**
Per maggiori dettagli su lubrificazione e tappi olio vedi il nostro sito web

RADIAL AND AXIAL LOADS

Output shaft
Albero di uscita

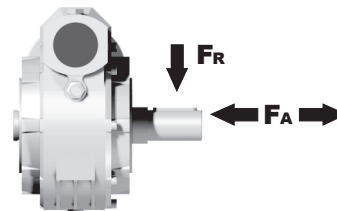

n_2 [min ⁻¹]	FA [N]	FR [N]
75	800	4000
50	920	4600
25	1200	6000
15-6	1400	7000

Input shaft
albero in entrata

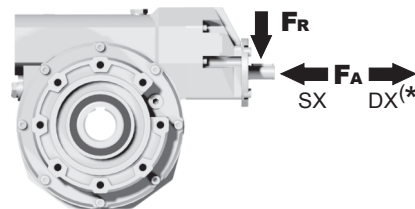

n_1 [min ⁻¹]	FA [N]	FR [N]
1400	150	760

***Strong axial loads in the DX direction are not allowed.**
Non sono consentiti forti carichi assiali con direzione DX

tab. 2

PP10**FB**... Basic wormbox
Riduttore base

Gearbox weight
peso riduttore **41.00 kg**

M. flanges	Kit code	øF	A
63B5	K063.4.041	140	214.7
71B5	K063.4.042	160	212.7
80/90B5	K063.4.043	200	214.7
71B14	K063.4.047	105	212.7
80B14	K063.4.046	120	214.7
90B14	K063.4.041	140	214.7

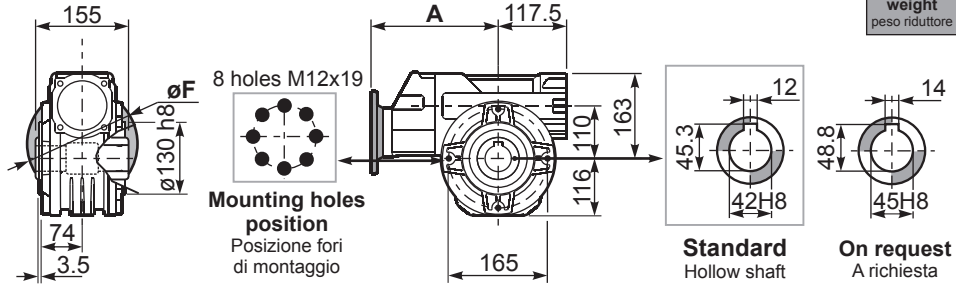

Standard
Hollow shaft

On request
A richiesta

PP10**PA**... Feet
Piedini

PP10**PB**... Feet
Piedini

PP10**PV**... Feet
Piedini

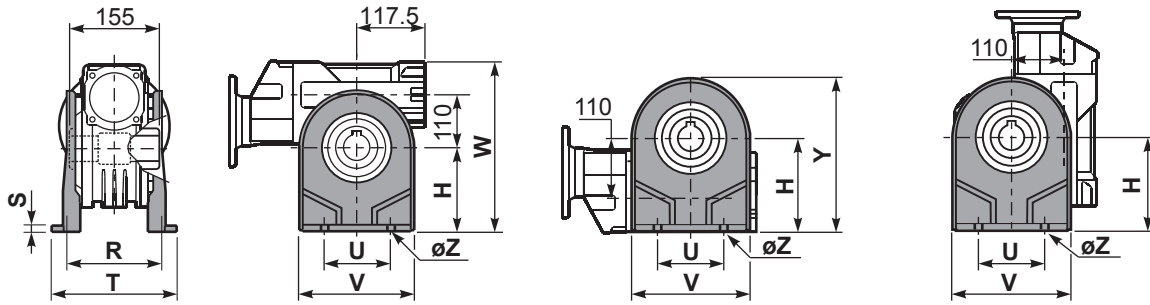

	H	R	S	T	U	V	Y	W	øZ	kit code
type B	170	180	22	224	200	240	286	333	ø13	K110.9.022
type S	172	160	8	204	200	240	288	335	ø14	KS110.9.023

PP10**FC**... Output flange
Flangia uscita

PP10**BR**... Reaction arm
Braccio di reazione

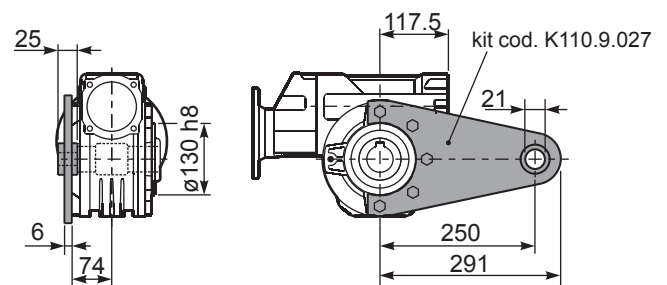
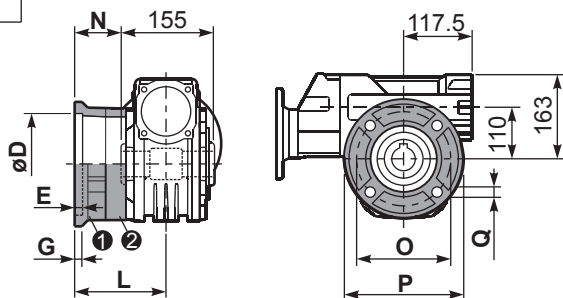

type B	øD	E	G	L	N	O	P	Q	kit code
FC	170 ^{+0.083} / ₀ ^{+0.043}	11	16.5	131.5	54	230	270	13	① K110.9.010 ② -
FL	170 ^{+0.083} / ₀ ^{+0.043}	11	16.5	179.5	102	230	270	13	① K110.9.011 ② -

type S	øD	E	G	L	N	O	P	Q	kit code
F1	180 ^{+0.040} / ₀	5	18	150	72.5	215	250	15	① KS110.9.014 ② -
F2	170 ^{+0.083} / ₀ ^{+0.043}	9.5	15	178	100.5	230	270	13	① KS110.9.012 ② -
F3	180 ^{+0.040} / ₀	5	18	130	52.5	215	250	15	① KS110.9.013 ② -

PP10.....**S**... Single Shaft
Albero lento semplice

PP10.....**D**... Double Shaft
Albero lento bisp.

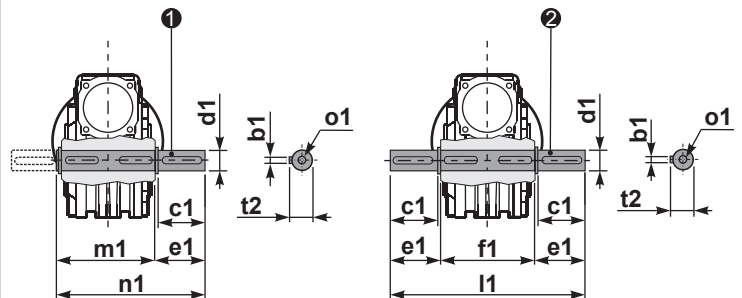

① kit cod. K110.5.028 type B

② kit cod. K110.5.029 type B

RP10**FB**... Input shaft
Albero in entrata

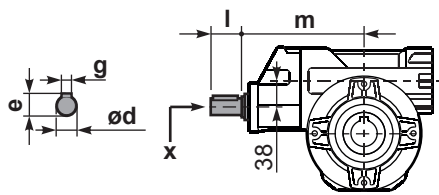

	ød	e	g	l	m	x
type B	19 h6	21.5	6	35	205	M6x16
type S	-	-	-	-	-	-

	b1	c1	d1	e1	f1	l1	m1	n1	t2	o1
type B	12	75	42 ^{-0.005} / ₀ ^{-0.020}	96.5	155	348	163.5	260	45	M12x32
type S	-	-	-	-	-	-	-	-	-	-