

## 6.0

### RINVII ANGOLARI R

### RIGHT ANGLE GEARBOX R

### WINKELGETRIEBE R

6.1	Caratteristiche	<i>Characteristics</i>	Merkmale	96
6.2	Designazione	<i>Designation</i>	Bezeichnung	97
6.3	Velocità in entrata	<i>Input speed</i>	Antriebsdrehzahl	97
6.4	Rendimento	<i>Efficiency</i>	Wirkungsgrad	98
6.5	Giochi angolari	<i>Angular backlash</i>	Winkelspiel	98
6.6	Potenza termica	<i>Thermal power</i>	Thermische Leistung	98
6.7	Dati tecnici	<i>Technical data</i>	Technische Daten	99
6.8	Senso di rotazione alberi	<i>Direction of shaft rotation</i>	Drehrichtungen der Wellen	99
6.9	Momenti d'inerzia	<i>Moments of inertia</i>	Trägheitsmoment	100
6.10	Dimensioni	<i>Dimensions</i>	Abmessungen	102
6.11	Accessori	<i>Accessories</i>	Zubehör	104
6.12	Lubrificazione	<i>Lubrication</i>	Schmierung	104
6.13	Carichi radiali e assiali (N)	<i>Radial and axial loads (N)</i>	Radial- und Axialbelastungen (N)	105
6.14	Lista parti di ricambio	<i>Spare parts list</i>	Ersatzteilliste	106

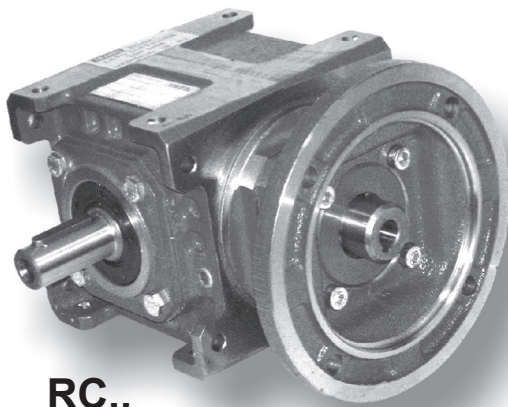

**RC..**

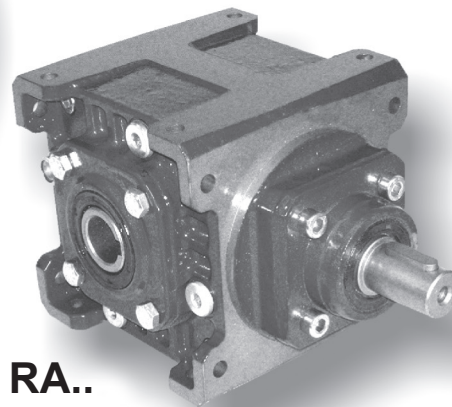

**RA..**

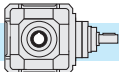

## 6.1 Caratteristiche

- Costruiti in 5 grandezze con tre tipi di albero uscita: cavo, sporgente, bisporgente. E' possibile inoltre disporre di un ulteriore albero di uscita opposto a quello di entrata.
- Sono previsti tre tipi di entrata: con albero sporgente, con predisposizione attacco motore (campana e giunto) e predisposizione attacco motore COMPACT.
- Il corpo riduttore in ghisa meccanica EN GJL 200 UNI EN 1561 abbondantemente nervato all'interno e all'esterno per garantire la rigidità, è lavorato su tutti i piani per consentire un facile posizionamento; inoltre un'unica camera di lubrificazione garantisce una maggiore dissipazione termica e una migliore lubrificazione di tutti gli organi interni.
- Il cinematismo di questi rinvii è costituito da una coppia di ingranaggi conici a dentatura spirooidale GLEASON con profilo accuratamente rodato, in acciaio 16CrNi4 o 18NiCrMo5.
- L'utilizzo di cuscinetti di qualità su tutti gli assi, consente al riduttore di ottenere durate molto elevate e di sopportare elevati carichi radiali e assiali.
- Il corpo riduttore, le flange, le campane ed i coperchi vengono verniciati esternamente di colore BLU RAL 5010.

## 6.1 Characteristics

- *Built in 5 sizes with three types of output shaft : hollow, projecting or double-extended. Moreover, an additional output shaft can be installed opposite to the input shaft.*
- *Three input types are available : with projecting input shaft, with pre-engineered motor coupling (bell and joint) and pre-engineered COMPACT motor coupling.*
- *Gear unit body in engineering cast iron, EN GJL 200 UNI EN 1561 ribbed internally and externally to guarantee rigidity and machined on all surfaces for easy positioning. The single lubrication chamber guarantees improved heat dissipation and better lubrication of all the internal components.*
- *The mechanism of these gearboxes consists of two GLEASON spiral bevel gears with precision lapped profile, 16CrNi4 or 18NiCrMo5 made of steel.*
- *The use of high quality bearings on all the axis ensures long life to the gearbox and allows very high radial and axial loads.*
- *Gearbox housing, flanges, bells and covers are externally painted with BLUE RAL 5010.*

## 6.1 Merkmale



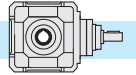





- Die Getriebe sind in 5 Baugrößen und 3 Abtriebsvarianten (Hohlwelle, einseitige Abtriebswelle und doppelseitige Abtriebswelle) erhältlich. Eine zusätzliche Abtriebswelle kann gegenüber dem Eintrieb montiert werden
- Drei Antriebsarten (Getriebeeingang) sind lieferbar: Eingangswelle, Motoranbau mit Glocke und Kupplung, Motor Direktanbau.
- Das Getriebegehäuse aus Maschinen-  
guß EN GJL 200 UNI EN 1561 ist sowohl innen als auch außen mit Rippen versehen, versehen, die die Steifheit leisten; die Bearbeitung aller Flächen ermöglicht eine leichte Positionierung; eine einzige Schmierkammer gewährleistet eine höhere Wärmedissipation und eine bessere Schmierung aller inneren Elemente.
- Die Vorgelege bestehen aus einem spiralverzahnten GLEASON-Kegelradpaar mit sorgfältig eingelaufenen Profil aus 16CrNi4- oder 18NiCrMo5-Stahl.
- An allen Achsen werden Qualitäts-Lager eingebaut. Diese gewährleisten eine hohe Lebensdauer und das Aushalten sehr hoher äußerer Radial- und Axialbelastungen.
- Getriebegehäuse, Flansche, Glocken und Deckel werden in BLAU RAL 5010 lackiert.

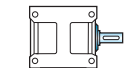
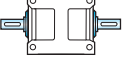
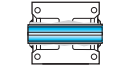
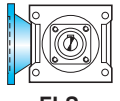
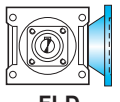

## 6.2 Designazione

## 6.2 Designation

## 6.2 Bezeichnung

Macchina Machine Maschine	Tipo entrata Input type Antriebsart	Grandezza Size Größe	Rotismo Gearing Räderwerk	Tipo uscita Output type Ausgang Typ	Rapporto rid. Ratio Untersetzungsverhältnis	Predisposizione att. mot. Motor coupling Motoranschluss	Rotazione alberi Shafts rotation Wellendrehrichtungen	Posizione di montaggio Mounting position Baulage	Flangia uscita Output flange Abtriebsflansch	Entrata supplementare Additional input Zusatzantrieb
<b>R</b>	<b>A</b>	<b>28</b>	<b>A</b>	<b>S</b>	<b>10</b>	<b>P.A.M.</b>	<b>B</b>	<b>B3</b>	<b>FLD</b>	<b>S.e.A.</b>
Rinvii angolari Right angle gearboxes Winkelgetriebe	 <b>A</b>  <b>C</b>  <b>F</b>	19 24 28 38 48	 <b>A</b>	 <b>S</b>  <b>B</b>  <b>C</b>	$i_n =$ 1 2.5 5 10	63 ÷ 200	<b>A</b> <b>B</b> <b>C</b> <b>D</b> <b>E</b> <b>F</b> <b>G</b> <b>H</b> <b>I</b> <b>L</b>	<b>B3</b> <b>B6</b> <b>B7</b> <b>B8</b> <b>VA</b> <b>VB</b>	 <b>FLS</b>  <b>FLD</b>  <b>FL2</b>	 <b>A</b>  <b>C</b>  <b>F</b>

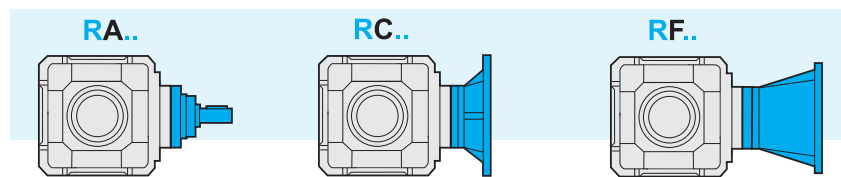

## 6.3 Velocità in entrata

Tutte le prestazioni dei riduttori sono calcolate in base ad una velocità in entrata di 1400 min<sup>-1</sup>.

La massima velocità ammessa in entrata è pari a 1400 min<sup>-1</sup>. Nel caso in cui tale limite debba essere superato contattare il servizio tecnico.

Nella tabella sottostante riportiamo i coefficienti correttivi della potenza in entrata P alle varie velocità riferita ad Fs =1

## 6.3 Input speed

All calculations of gear unit performance specifications are based on an input speed of 1400 min<sup>-1</sup>.

1400 min<sup>-1</sup> is the max. allowed input speed. For higher speed pls contact the technical service.

The table below shows the input power P corrective coefficients at the various speeds, with Fs =1.

## 6.3 Antriebsdrehzahl

Bei der Berechnung der Getriebeleistungen wurde eine Antriebsdrehzahl von 1400 Min-1 zugrunde gelegt.

1400 Min-1 ist die max. zulässige Antriebsdrehzahl. Falls die verlangte Antriebsdrehzahl höher ist, muss mit dem technischen Büro Rücksprache gehalten werden.

In der folgenden Tabelle finden Sie die Korrekturkoeffizienten für die Antriebsleistung P bei den verschiedenen Drehzahlen, bezogen auf Fs=1.

Tab. 1

n <sub>1</sub> [min <sup>-1</sup> ]	1400	900	700	500
P <sub>c</sub> (kW)	P x 1	P x 0.7	P x 0.56	P x 0.42

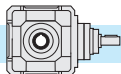

#### 6.4 Rendimento

Il valore del rendimento dei riduttori può essere stimato con sufficiente approssimazione (**R=0.97**), trascurando le variazioni non significative attribuibili ai vari rapporti.

#### 6.4 Efficiency

*The efficiency value of the gearbox can be estimated (**R = 0.97**) ignoring non-significant variations which can be attributed to the various ratios.*

#### 6.4 Wirkungsgrad

Der Wirkungsgrad der Getriebe kann mit ausreichender Annäherung ermittelt werden (**R = 0.97**), dabei können die unwesentlichen Veränderungen, die auf die verschiedenen Untersetzungsverhältnisse zurückzuführen sind, außer Acht gelassen werden.

#### 6.5 Giochi angolari

Bloccando l'albero di entrata, il gioco viene misurato sull'albero uscita ruotandolo nelle due direzioni ad applicando la coppia strettamente necessaria a creare il contatto tra i denti degli ingranaggi al max pari al 2% della coppia massima garantita dal riduttore.

Nella tabella seguente sono riportati i valori del gioco angolare (in minuti di angolo) per quanto riguarda il montaggio normale ed i valori ottenibili con una registrazione più precisa. Quest'ultima esecuzione è da utilizzare solo in caso di reale necessità in quanto potrebbe comportare un leggero aumento della rumorosità e rendere meno efficace l'azione dell'olio lubrificante.

#### 6.5 Angular backlash

*After having blocked the input shaft, the angular backlash can be measured on the output shaft by rotating it in both directions and applying the torque which is strictly necessary to create a contact between the teeth of the gears. The applied torque should be at most 2% of the max. torque guaranteed by the gearbox.*

*The following table reports the approximate value of the angular backlash (in minutes of arc) referred to standard mounting and the values to be obtained by a more precise adjustment. The latter solution should be adopted only in case of necessity because it may raise the noise level and lessen the action of the lubricant.*

#### 6.5 Winkelspiel

Nachdem die Antriebswelle blockiert worden ist, kann das Winkelspiel auf der Abtriebswelle gemessen werden. Indem die Abtriebswelle in beiden Richtungen verdreht und ein Drehmoment ausgeübt wird, da zu einem Kontakt zwischen den Zähnen führt. Das ausgeübte Drehmoment soll 2% des max. zulässigen Drehmoments ( $T_{2M}$ ) nicht übersteigen. Die folgende Tabelle zeigt die Näherungswerte des Winkelspiels (in Bogenminuten) für Standardmontage und Montage mit präziser Einstellung. Diese Lösung darf nur im Notfall angewendet werden, weil dabei der Geräuschpegel zunimmt und die Wirkung des Schmiermittels abnimmt.

Gioco angolare / Backlash / Winkelspiel (1')	
Montaggio normal Standard mounting Standardmontage	Montaggio con gioco ridotto Mounting with reduced backlash Montage mit reduziertem Winkelspiel
12/20	8

#### 6.6 Potenza termica

I valori delle potenze termiche,  $P_{10}$  (kW), relative alle diverse grandezze di rinvii angolari sono riportati nella tabella seguente.

#### 6.6 Thermal power

*The following table shows the values of thermal power  $P_{10}$  (kW) for each gearbox size.*

#### 6.6 Thermische Leistung

Die folgende Tabelle zeigt die Werte  $P_{10}$  der thermischen Leistung (kW) je nach Getriebegröße.

Tab. 2

$n_1$ [min <sup>-1</sup> ]	$P_{10}$ [kW] - Potenza Termica / Thermal power / Thermische Leistung				
	R19	R24	R28	R38	R48
1400	4.5	6.7	10.3	15.3	22.4

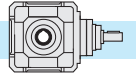

6.7 Dati tecnici

6.7 Technical data

6.7 Technische Daten

R	n <sub>1</sub> = 1400			RC - RF			RA	
	in	ir	n <sub>2</sub> rpm	T <sub>2</sub> Nm	P1 kW	FS'	T <sub>2M</sub> Nm	P kW
19	1	1	1400	12	1.8	3	35	5.5
	2.5	2.56	546	30	1.8	1.6	50	3
	5	4.90	285	48	1.5	1	48	1.5
	10	9.85	142	48	0.75	1	48	0.75
24	1	1	1400	26	4	2.7	73	11
	2.5	2.56	546	68	4	1.4	93	5.5
	5	4.90	285	97	3	1	97	3
	10	9.85	142	98	1.5	1	98	1.5
28	1	1	1400	61	9.2	2.4	146	22
	2.5	2.56	546	156	9.2	1.2	187	11
	5	4.90	285	179	5.5	1	179	5.5
	10	9.85	142	196	3	1	196	3

R	n <sub>1</sub> = 1400			RC - RF			RA	
	in	ir	n <sub>2</sub> rpm	T <sub>2</sub> Nm	P1 kW	FS'	T <sub>2M</sub> Nm	P kW
38	1	1	1400	146	22	2	291	45
	2.5	2.56	546	373	22	1	365	22
	5	4.90	285	357	11	1	350	11
	10	9.85	142	359	5.5	1	350	5.5
48	1	1	1400	199	30	3	596	90
	2.5	2.56	546	509	30	1.5	763	45
	5	4.90	285	715	22	1	715	22
	10	9.85	142	717	11	1	717	11

Verifica termica necessaria / Thermal rating needed / Thermische - Prüfung erforderlich

R	i	IEC									
		63	71	80	90	100	112	132	160	180	200
19	1	RC - RF									
	2.5-5-10	RC - RF									
24	1	RC - RF									
	2.5-5-10	RC - RF									
28	1	RC - RF									
	2.5-5-10	RC - RF									
38	1	RC - RF									
	2.5-5-10	RC - RF									
48	1	RC - RF									
	2.5-5-10	RC - RF									

6.8 Senso di rotazione alberi

6.8 Shaft Rotation Direction

6.8 Wellendrehrrichtungen

s.e. = Entrata supplementare / Additional input / Zusatzantrieb

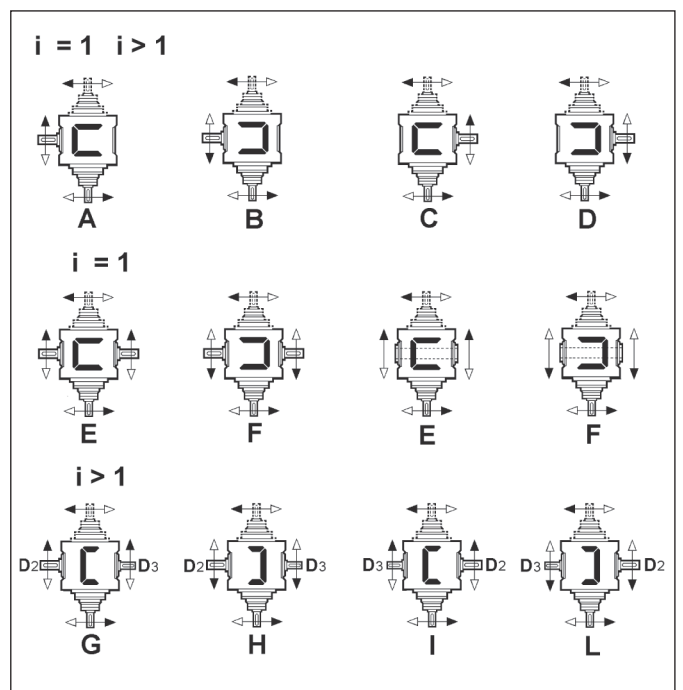
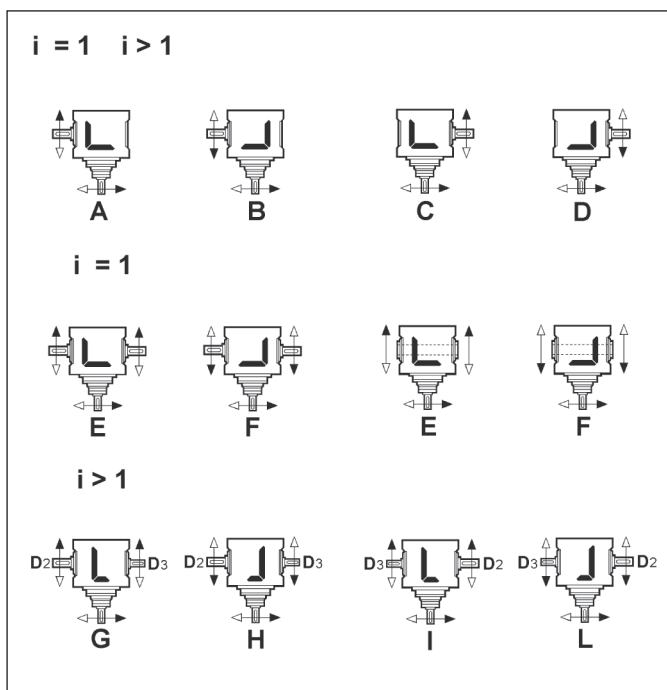

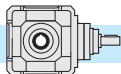











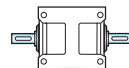





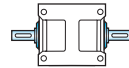

**6.9 Momenti d'inerzia [Kg·cm<sup>2</sup>]**  
(riferiti all'albero veloce in entrata)

**6.9 Moments of inertia [Kg·cm<sup>2</sup>]**  
(referred to input shaft)

**6.9 Trägheitsmoment [Kg·cm<sup>2</sup>]**  
(bez. Antriebswelle)

		$i_n$	RA 	RC 				RF 			
				IEC B5				IEC B5			
				63	71	80	90	63	71	80	90
<b>19</b>	<b>S</b> 	1	4.53	4.15	4.28	4.65	4.68	4.81	5.31	5.44	6.51
		2.5	0.88	0.93	1.07	1.45	1.50	1.13	1.15	1.82	2.89
		5	0.36	0.41	0.55	0.93	0.97	0.61	0.63	1.31	2.37
		10	0.19	0.22	0.36	0.74	0.79	0.44	0.46	1.14	2.20
	<b>B</b> 	1	4.57	4.19	4.33	4.70	4.73	4.84	5.34	5.48	6.55
		2.5	0.88	0.93	1.07	1.45	1.50	1.13	1.15	1.83	2.89
		5	0.36	0.41	0.55	0.93	0.97	0.61	0.63	1.31	2.37
		10	0.19	0.22	0.36	0.74	0.79	0.44	0.46	1.14	2.20
	<b>C</b> 	1	4.17	3.93	4.07	4.44	4.47	4.45	4.95	5.08	6.16

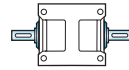
		$i_n$	RA 	RC 				RF 			
				IEC B5				IEC B5			
				71	80	90	110-112	71	80	90	110-112
<b>24</b>	<b>S</b> 	1	11.52	11.27	11.43	11.80	12.62	13.36	13.69	13.61	15.39
		2.5	2.46	2.87	3.04	3.42	4.26	3.32	3.46	4.63	6.80
		5	1.08	1.45	1.62	2.00	2.84	1.94	2.07	3.25	5.42
		10	0.64	0.97	1.14	1.52	2.36	1.49	1.63	2.80	4.97
	<b>B</b> 	1	11.60	11.38	11.54	11.91	12.73	13.45	13.77	13.70	15.47
		2.5	2.47	2.88	3.05	3.43	4.27	3.33	3.47	4.64	6.81
		5	1.08	1.45	1.62	2.00	2.84	1.94	2.07	3.25	5.42
		10	0.64	0.97	1.14	1.52	2.36	1.49	1.63	2.80	4.97
	<b>C</b> 	1	10.48	10.62	10.78	11.14	11.97	12.32	12.64	12.57	14.34



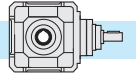



		$i_n$	RA 	RC 				RF 			
				IEC B5				IEC B5			
				80	90	110-112	132	80	90	110-112	132
<b>28</b>	<b>S</b> 	1	31.45	28.26	28.12	29.01	32.12	35.79	35.74	35.91	46.94
		2.5	7.02	7.95	7.82	8.78	11.92	9.36	9.29	11.60	25.60
		5	3.22	4.06	3.93	4.88	8.02	5.55	5.48	7.80	21.79
		10	1.75	2.46	2.33	3.28	6.42	4.08	4.01	6.33	20.32
	<b>B</b> 	1	31.87	28.73	28.59	29.47	32.59	36.21	36.16	36.34	47.36
		2.5	7.05	7.98	7.85	8.80	11.94	9.38	9.31	11.63	25.62
		5	3.23	4.06	3.93	4.88	8.02	5.56	5.49	7.81	21.80
		10	1.75	2.46	2.33	3.28	6.42	4.08	4.01	6.33	20.33
	<b>C</b> 	1	28.36	26.95	26.82	27.70	30.81	32.69	32.65	32.82	43.84









6.9 **Momenti d'inerzia** [Kg·cm<sup>2</sup>]  
(riferiti all'albero veloce in entrata)

6.9 **Moments of inertia** [Kg·cm<sup>2</sup>]  
(referred to input shaft)

6.9 **Trägheitsmoment** [Kg·cm<sup>2</sup>]  
(bez. Antriebswelle)

		$i_n$													
				IEC B5					IEC B5						
				80	90	110-112	132	160	180	80	90	110-112	132	160	180
<b>38</b>		1	82.73	73.23	73.09	73.20	76.34	80.53	83.31	99.45	99.4	100.4	101.8	103.9	149.0
		2.5	20.67	21.83	21.70	21.84	25.04	29.46	32.48	22.87	25.25	25.43	40.29	42.47	87.73
		5	7.92	8.95	8.82	8.95	12.15	16.58	19.60	10.12	12.50	12.67	27.53	29.71	74.98
		10	4.17	4.83	4.70	4.84	8.04	12.46	15.48	6.36	8.75	8.92	23.78	25.96	71.23
		1	84.86	75.54	75.40	75.50	78.65	82.84	85.62	99.45	101.49	102.53	103.90	106.08	151.18
		2.5	20.74	21.90	21.77	21.91	25.11	29.53	32.55	22.94	25.32	25.49	40.35	42.53	87.80
		5	7.94	8.96	8.83	8.97	12.17	16.60	19.61	10.13	12.52	12.69	27.55	29.73	75.00
		10	4.17	4.83	4.70	4.84	8.04	12.47	15.48	6.37	8.75	8.93	23.79	25.97	71.23
		1	76.44	68.61	68.47	68.57	71.71	75.91	78.68	93.25	93.17	94.21	95.57	97.75	142.86

		$i_n$											
				IEC B5					IEC B5				
				110-112	132	160	180	200	110-112	132	160	180	200
<b>48</b>		1	177.58	177.7	183.4	182.4	185.3	195.7	233.7	238.9	246.9	244.9	241.4
		2.5	61.86	64.36	70.04	69.04	71.95	82.34	81.5	82.8	85.0	134.1	130.7
		5	24.06	26.80	32.48	31.48	34.39	44.78	43.7	45.0	47.2	96.3	92.9
		10	11.50	13.77	19.45	18.45	21.36	31.75	31.1	32.5	34.7	83.8	80.3
		1	183.40	183.5	189.2	188.2	191.1	201.5	239.5	244.7	252.7	250.7	247.2
		2.5	62.11	64.70	70.38	69.38	72.29	82.68	81.7	83.1	85.3	134.4	130.9
		5	24.13	26.89	32.57	31.57	34.48	44.87	43.7	45.1	47.3	96.4	92.9
		10	11.52	13.80	19.48	18.48	21.39	31.77	31.1	32.5	34.7	83.8	80.3
		1	160.10	160.8	166.5	165.5	168.4	178.8	-	221.4	229.4	227.4	223.9



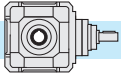

6.10 Dimensioni

6.10 Dimensions

6.10 Abmessungen

		RA...- RC...- RF...					
		19	24	28	38	48	
A	i = 1	112	142	180	224	280	
a		80	100	130	160	190	
B		128	146	175	204	230	
b		110	125	145	175	200	
C2		130	150	180	210	240	
D2 <sub>h6</sub>		19	24	28	38	48	
d2		M8	M8	M8	M10	M12	
M2		21.5	27	31	41	51.5	
N2		6	8	8	10	14	
F		7	9	11	13	15	
H		56	71	90	112	140	
L2		40	50	60	80	110	
Z		7	9	10	13	15	
D3 <sub>h6</sub>		i = 1	19	24	28	38	48
d3			M8	M8	M8	M10	M12
L3	40		50	60	80	110	
M3	21.5		27	31	41	51.5	
N3	6		8	8	10	14	
D4 <sub>H7</sub>	20		25	30	40	50	
M4	22.8		28.3	33.3	43.3	53.8	
N4	6		8	8	12	14	
D3 <sub>h6</sub>	i > 1	14	19	24	28	38	
d3		M6	M8	M8	M10	M10	
L3		30	40	50	60	80	
M3		16	21.5	27	31	41	
N3		5	6	8	8	10	

		RA				
		19	24	28	38	48
h	i = 1	101	120	147	170	207.5
D1 <sub>h6</sub>		19	24	28	38	48
d1		M8	M8	M8	M10	M12
M1		21.5	27	31	41	51.5
N1		6	8	8	10	14
h	i > 1	110	130	160	190	237.5
D1 <sub>h6</sub>		14	19	24	28	38
d1		M6	M8	M8	M8	M10
M1		16	21.5	27	31	41
N1		5	6	8	8	10
L1	i = 1	30	40	50	60	80
X	i > 1	90	110	130	150	175
kg		8.5	14	23	38	62
		RC...- RF...				
kg		11.5	19	33	55	82



		RC...								
		19				24				
IEC		63 B5	71 B5	80/90 B5	80 B14	71 B5	80 B5	90 B5	90* B14	100/112 B5
Q		—	—	—	—	—	—	—	120	—
Y		140	160	200	120	160	200	200	146	250
P	i = 1	104	111	131	131	128	148	148	148	158
P	i > 1	113	120	140	140	138	158	158	158	168



		RC...											
		28			38				48				
IEC		80/90 B5	100/112 B5	132 B5	80 B5	90 B5	100/112 B5	132 B5	160/180 B5	100/112 B5	132 B5	160/180 B5	200 B5
Y		200	250	300	200	200	250	300	350	250	300	350	400
P	i = 1	171	181	203	184	184	194	216	246	220	240	270	270
P	i > 1	184	194	216	204	204	214	236	266	250 (i=2.5 - 5) 260 (i=10)	270 (i=2.5 - 5) 280 (i=10)	300 (i=2.5 - 5) 310 (i=10)	

\* Flange quadrate / Square flanges / Viereckige Flansche

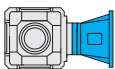

		RF...																
		19			24			28			38				48			
IEC		63 B5	71 B5	80/90 B5	71 B5	80/90 B5	100/112 B5	80/90 B5	100/112 B5	132 B5	80/90 B5	100/112 B5	132 B5	160/180 B5	100/112 B5	132 B5	160/180 B5	200 B5
Y		140	160	200	160	200	250	200	250	300	200	250	300	350	250	300	350	400
P	i = 1	158	165	186	194	215	225	252	262	283	285	295	316	346	354	373	405	405
P	i > 1	167	174	195	204	225	235	265	275	296	305	315	336	366	384	403	435	435



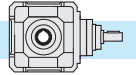

Tipo entrata / Input type / Antriebsart

Tipo uscita / Output type / Ausgang Typ

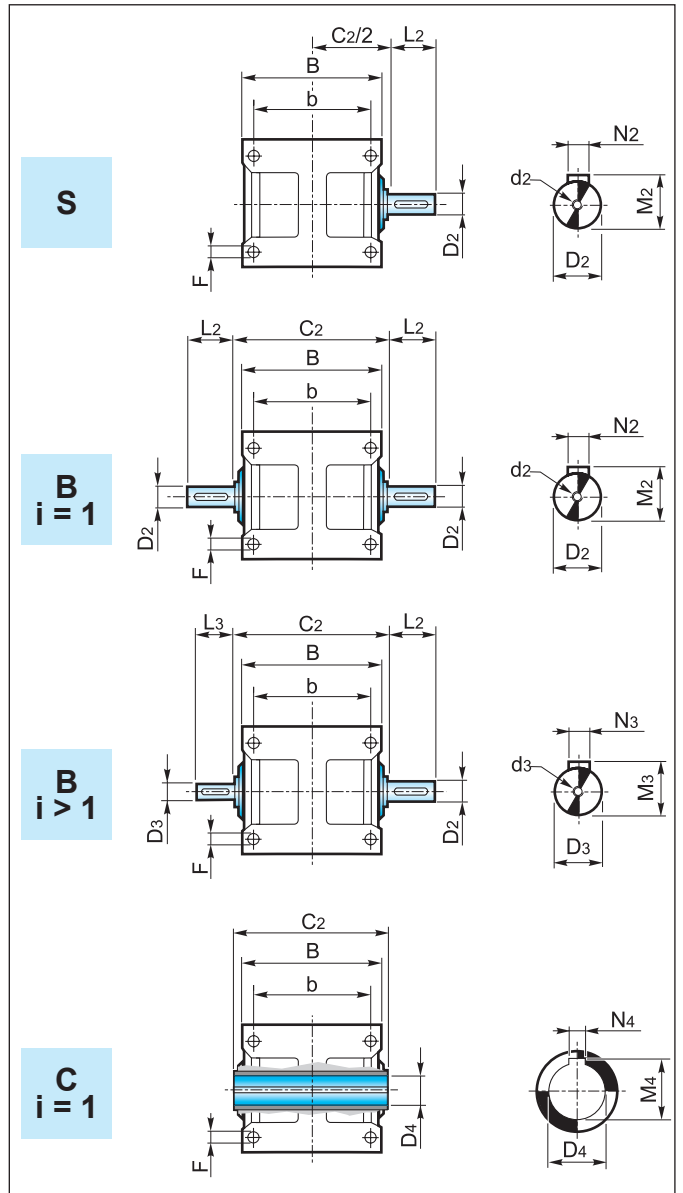
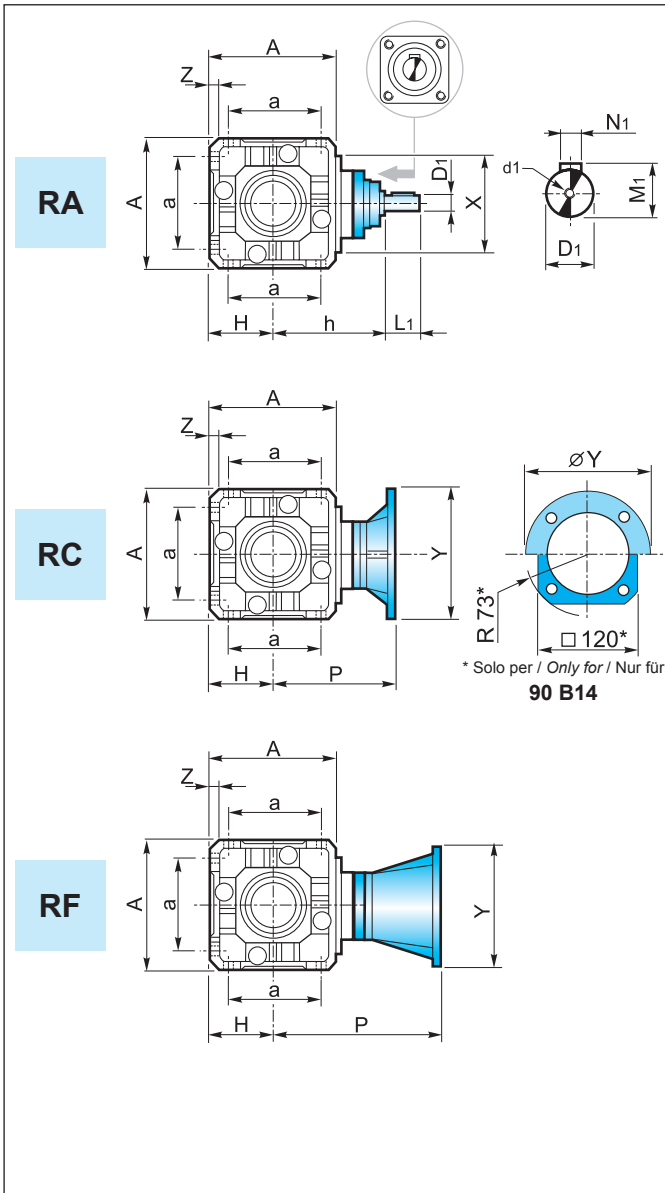

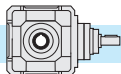

**6.11 Accessori**

**6.11 Accessories**

**6.11 Zubehör**

**Flangia uscita**

**Output flange**

**Abtriebsflansch**

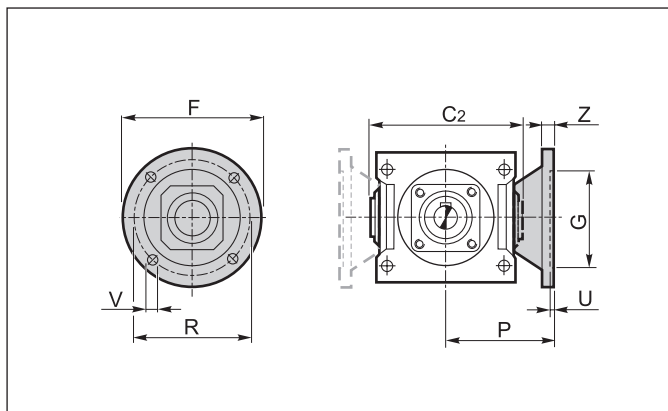

	R				
	19	24	28	38	48
<b>C2</b>	130	150	180	210	240
<b>F</b>	140	160	200	250	250
<b>G<sub>F7</sub></b>	95	110	130	180	180
<b>P</b>	86	100	120	145	175
<b>R</b>	115	130	165	215	215
<b>U</b>	3.5	4	4.5	5	5
<b>V</b>	9	11	13	15	15
<b>Z</b>	10	12.5	16	20	20

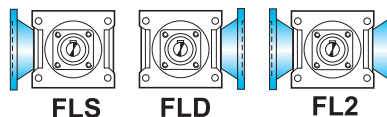

**6.12 Lubrificazione**

**6.12 Lubrication**

**6.12 Schmierung**

I rinvii angolari sono forniti predisposti per lubrificazione a olio e muniti dei tappi di carico, livello e scarico olio.

*Right angle gearboxes require oil lubrication and are equipped with filler, level and drain plugs.*

Die Winkelgetriebe sind für die Ölschmierung mit Einfüll-, Ölstand- und Ablassstopfen versehen.

Si raccomanda di precisare sempre la posizione di montaggio desiderata in fase di ordine.

*The mounting position should always be specified when ordering the gearbox.*

Bei der Bestellung ist immer die gewünschte Montageposition anzugeben.

Il rinvio grandezza 19 viene fornito lubrificato a vita e non è previsto il tappo di sfiato.

*The right angle gearbox size 19 is lubricated for life and without breather plug.*

Das Winkelgetriebe Größe 19 ist Lebensdauer geschmiert und ohne Entlüftungsschraube.

**Posizione di montaggio e quantità di lubrificante (litri)**

**Mounting positions and lubricant quantity (litres)**

**Montageposition und Ölmenge (Liter)**

I quantitativi di olio riportati nelle varie tabelle sono indicativi e riferiti alle posizioni di lavoro indicate e considerando le condizioni di funzionamento a temperatura ambiente e velocità in ingresso di 1400 min<sup>-1</sup>. Per condizioni di lavoro diverse da quelle sopra riportate contattare il servizio tecnico.

*The oil quantities stated in the tables are approximate values and refer to the indicated working positions, considering operating conditions at ambient temperature and an input speed of 1400 min<sup>-1</sup>. Should the operating conditions be different, please contact the technical service.*

Die in der Tabellen angegebenen Daten sind Richtwerte. Die Ölmenge beziehen sich auf die angegebene Betriebsposition. Dabei werden Betrieb bei Umgebungtemperatur und Antriebsdrehzahl von 1400 min<sup>-1</sup> berücksichtigt. Falls die Betriebsbedingungen anders sind, dann ist das technische Büro zu befragen.

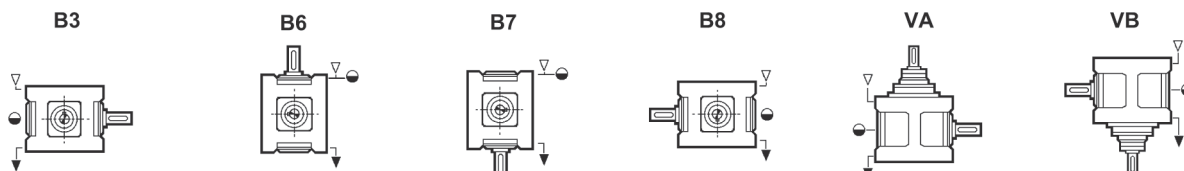

R	B3	B6	B7	B8	VA	VB
<b>19</b>	0.2	0.2	0.2	0.2	0.2	0.2
<b>24</b>	0.4	0.8	0.8	0.4	0.6	0.5
<b>28</b>	0.9	0.8	0.8	0.8	0.9	0.8
<b>38</b>	1.6	3.0	3.0	2.0	2.7	2.7
<b>48</b>	4.0	5.6	5.6	4.0	5.6	5.6

**Posizione morsettiera**

**Terminal board position**

**Lage des Klemmenkastens**

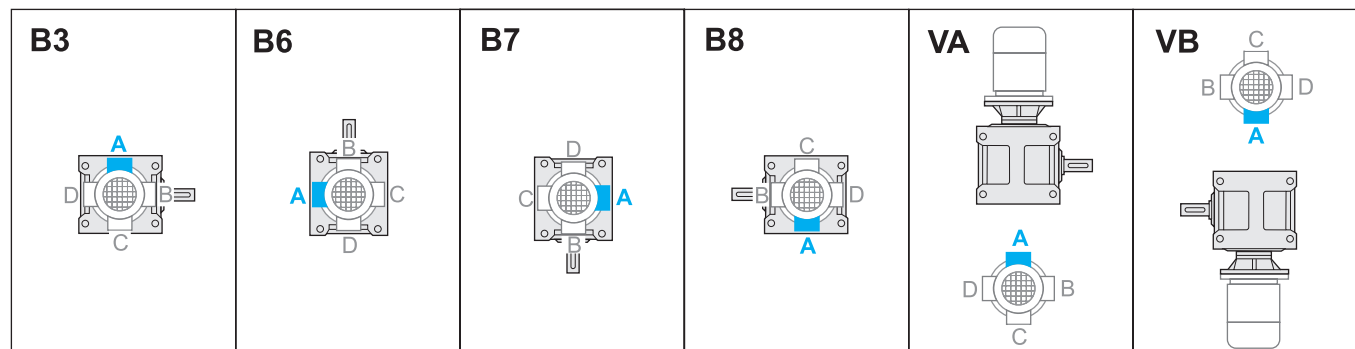

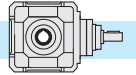

### 6.13 Carichi radiali e assiali (N)

Le trasmissioni effettuate tramite pignoni per catena, ruote dentate o pulegge generano delle forze radiali ( $F_R$ ) sugli alberi dei riduttori. L'entità di tali forze può essere calcolata con la formula:

### 6.13 Radial and axial loads (N)

Transmissions implemented by means of chain pinions, wheels or pulleys generate radial forces ( $F_R$ ) on the gear unit shafts. The entity of these forces may be calculated using the following formula:

### 6.13 Radial- und Axialbelastungen (N)

Antriebe mit Kettenritzel, Zahnrädern oder Riemscheiben erzeugen radiale Kräfte ( $F_R$ ) an den Wellen der Untersetzungsgetriebe. Die Größe dieser Kraft kann nach folgender Formel berechnet werden:

$$F_R = \frac{K_R \cdot T}{d} \text{ [N]}$$

dove:

T = Momento torcente [Nm]  
d = Diametro pignone o puleggia [mm]

$K_R$  = 2000 per pignone per catena  
= 2500 per ruote dentate  
= 3000 per puleggia con cinghie a V

where:

T = torque [Nm]  
d = pinion or pulley diameter [mm]

$K_R$  = 2000 for chain pinion  
= 2500 for wheel  
= 3000 for V-belt pulley

dabei ist:

T = Drehmoment [Nm]  
d = Kettenritzel- bzw. Riemscheiben durchmesser [mm]

$K_R$  = 2000 bei Kettenritzel  
= 2500 bei Zahnrad  
= 3000 bei Riemscheibe mit Keilriemen

I valori dei carichi radiali e assiali generati dall'applicazione debbono essere sempre minori o uguali a quelli ammissibili indicati nelle tabelle.

The values of the radial and axial loads generated by the application must always be lower than or equal to the admissible values reported in the tables.

Die Werte der Radial- und Axialbelastungen, die durch die Anwendung hervorgerufen werden, dürfen nicht über den in den Tabellen angegebenen zulässigen Werten liegen.

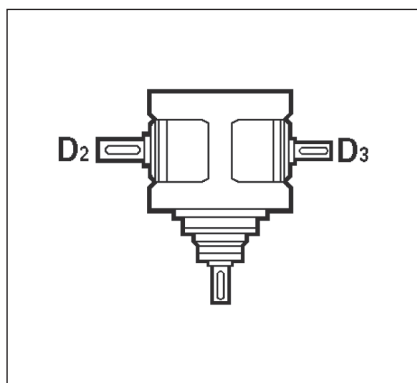
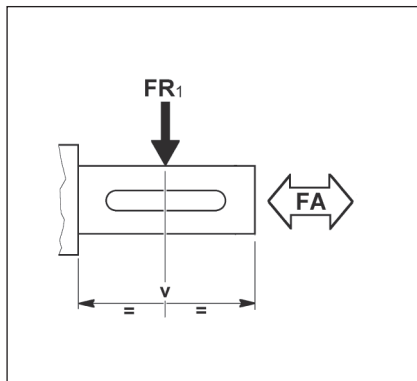

$i_n$	Albero Shaft Welle	R									
		19		24		28		38		48	
<b>ALBERO ENTRATA / INPUT SHAFT / ANTRIEBSWELLE (<math>n_1 = 1400 \text{ min}^{-1}</math>)</b>											
		$Fr_1$	$Fa_1$	$Fr_1$	$Fa_1$	$Fr_1$	$Fa_1$	$Fr_1$	$Fa_1$	$Fr_1$	$Fa_1$
Tutti All Alle	Tutti All Alle	400	80	630	125	1000	200	1600	320	2500	500
<b>ALBERO USCITA / OUTPUT SHAFT / ABTRIEBSWELLE (<math>n_1 = 1400 \text{ min}^{-1}</math>)</b>											
		$Fr_2$	$Fa_2$	$Fr_2$	$Fa_2$	$Fr_2$	$Fa_2$	$Fr_2$	$Fa_2$	$Fr_2$	$Fa_2$
1	Tutti All Alle	800	160	1250	250	2000	400	3150	630	5000	1000
2.5	D2	1000	200	1600	320	2500	500	4000	800	6300	1260
	D3	630	130	1000	200	1600	320	2500	500	4000	800
5	D2	1250	250	2000	400	3150	630	5000	1000	8000	1600
	D3	800	160	1250	250	2000	400	3150	630	5000	1000
10	D2	1600	320	2500	500	4000	800	6300	1260	10000	2000
	D3	1000	200	1600	320	2500	500	4000	800	6300	1260

I carichi radiali indicati nelle tabelle si intendono applicati a metà della sporgenza dell'albero e sono riferiti ai riduttori operanti con fattore di servizio 1.

The radial loads reported in the table are considered to be applied at the half-way point of the shaft projection and refer to gear units operating with service factor 1.

Die Radialbelastungen, die in den Tabellen angegeben werden, gelten für Ansatzpunkte in der Mitte des herausragenden Wellenteils und für Getriebe mit Betriebsfaktor 1.

Nel caso di alberi bisporgenti il valore del carico applicabile a ciascuna estremità è uguale ai 2/3 del valore di tabella, purché i carichi applicati siano uguali di intensità e direzione ed agiscano nello stesso senso. Diversamente contattare il servizio tecnico.

With regard to double-projecting shafts, the load applicable at each end is 2/3 of the value given in the table, on condition that the applied loads feature same intensity and direction and that they act in the same direction. Otherwise please contact the technical department.

Bei doppelseitigen Wellen ist die Belastung, die an jedem Ende anwendbar ist, 2/3 des in der Tabelle angegebenen Wertes unter der Bedingung, dass sie in derselben Stärke und Richtung wirken. Andernfalls muß mit dem technischen Büro Rücksprache gehalten werden.

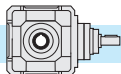

**RA - RC - RF (in = 1)**

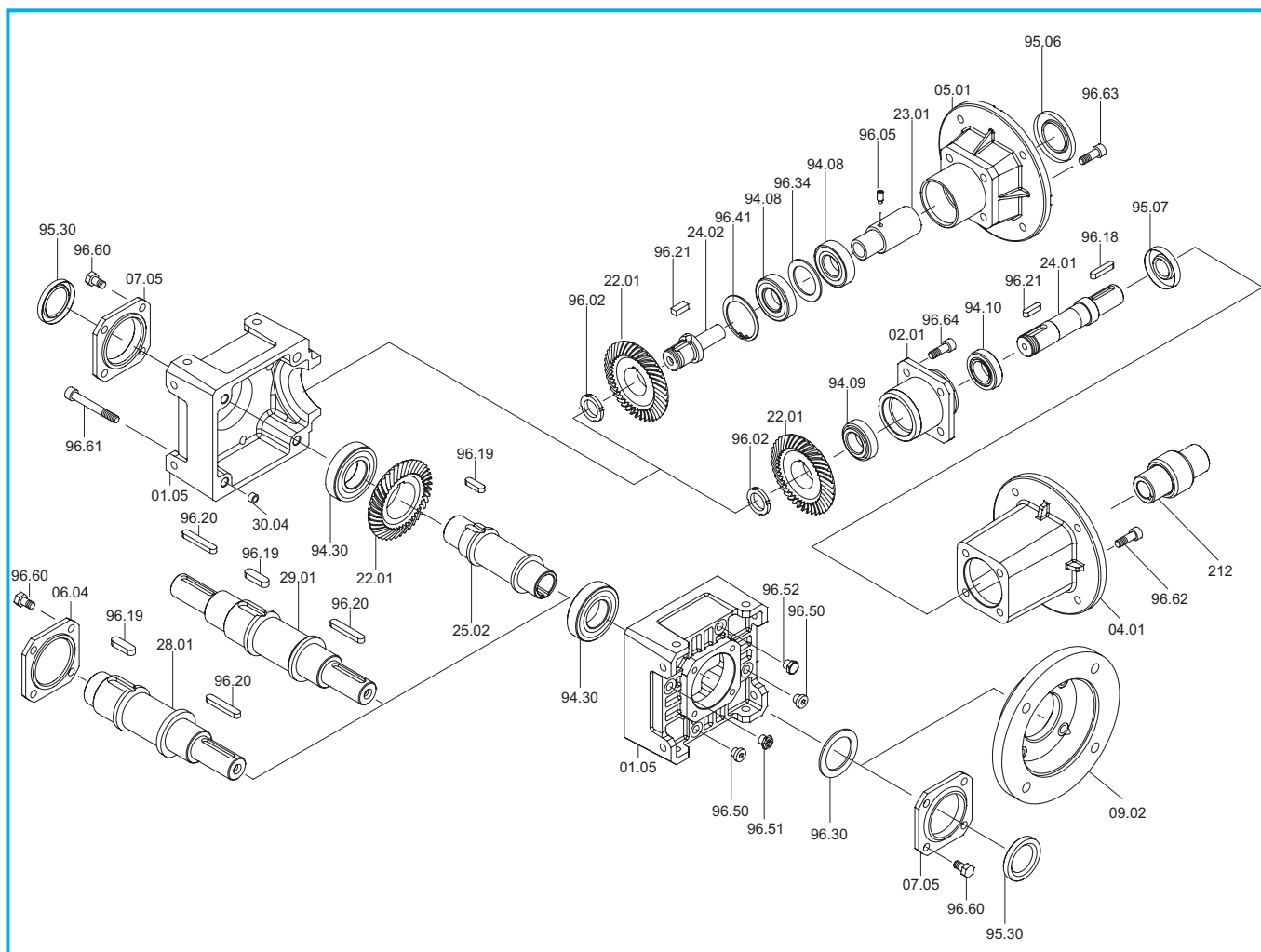

RA - RC - RF in = 1:1	Cuscinetti/ Bearings / Lager			Anelli di tenuta / Oilseals / Öldichtungen			
	RA - RC - RF	RA - RF	RC	RA - RC - RF	RC		RA - RF
	94.30	94.10 - 94.09	94.08	95.30	IEC	95.06	95.07
<b>19</b>	6206 30/62/16	30203 17/40/13.25	7203 17/40/12	30/47/7	63	25/52/7	20/40/7
					71	30/52/7	
					80	35/52/7	
					90	37/52/8	
<b>24</b>	6207 35/72/17	32005 25/47/15	7205 25/52/15	35/52/7	71 - 80	35/62/7	30/47/7
					90	40/62/7	
					100 - 112	45/62/8	
<b>28</b>	6208 40/80/18	32006 30/55/17	7206 30/62/16	40/62/8	80 - 90	40/72/7	35/58/10
					100 - 112	45/72/8	
					132	55/72/8	
					80 - 90	45/80/10	
<b>38</b>	30211 55/100/22.75	32007 35/62/18	7207 35/72/17	55/72/10	100 - 112	45/80/10	40/62/7
					132	55/80/10	
					160	60/80/8	
					180	65/80/8	
<b>48</b>	30213 65/120/24.75	33109 45/80/26	7209 45/85/19	65/90/10	100 - 112	55/100/13	55/80/8
					132 - 160	60/100/10	
					180	65/100/10	
					200	75/100/10	









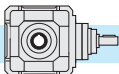

In fase di ordine delle parti di ricambio, specificare sempre n° particolare (vedi disegno esploso), data (1), n° codice (2) e n° variante (3). (Vedi targhetta).

When ordering a spare part, the spare part number (see exploded technical drawing), the date (1), the code number (2) and the variant number (3) should always be reported. (See plate)

Bei der Bestellung von Ersatzteilen sind Ersatzteilnummer (s. Explosionszeichnung), Datum (1), Artikelnummer (2) und Variantennummer (3) anzugeben. (s. Schild)

