

DATI TECNICI / TECHNICAL DATA / TECHNISCHE DATEN
 CARACTÉRISTIQUES TECHNIQUES / DATOS TÉCNICOS / CARACTERÍSTICAS TÉCNICAS

CV RCV	i	n ₁ = 2800 min ⁻¹			n ₁ = 1400 min ⁻¹			n ₁ = 900 min ⁻¹					
		n ₂ min ⁻¹	Mn ₂ Nm	P ₁ kW	n ₂ min ⁻¹	Mn ₂ Nm	P ₁ kW	n ₂ min ⁻¹	Mn ₂ Nm	P ₁ kW	IEC B5	IEC B14	NEMA
602	4.64	603	1382	91	302	1654	54	194	1654	35	90-100-112-132-160-180-200	132	180-210-250-280
	5.04	556	1418	86	278	1699	51	179	1699	33	90-100-112-132-160-180-200	132	180-210-250-280
	6.03	464	1633	83	232	1955	50	149	1955	32	90-100-112-132-160-180-200	132	180-210-250-280
	7.38	379	1958	81	190	2345	49	122	2345	31	90-100-112-132-160-180-200	132	180-210-250-280
	8.61	325	2144	76	163	2569	46	105	2569	29	90-100-112-132-160-180-200	132	180-210-250-280
	9.36	299	2179	71	150	2610	43	96	2609	27	90-100-112-132-160-180-200	132	180-210-250-280
	11.20	250	2447	67	125	2933	40	80	2933	26	90-100-112-132-160-180-200	132	180-210-250-280
	13.71	204	2289	51	102	2742	31	66	2742	19.6	90-100-112-132-160-180-200	132	180-210-250-280
	15.03	186	2510	51	93	3005	31	60	3005	19.6	90-100-112-132-160-180	132	180-210-250-280
	16.34	171	2617	49	86	3135	29	55	3134	18.8	90-100-112-132-160-180	132	180-210-250-280
	19.55	143	2535	40	72	3037	24	46.0	3037	15.3	90-100-112-132-160-180	132	180-210-250-280
	23.93	117	2366	30	59	2836	18.1	37.6	2836	11.6	90-100-112-132-160-180	132	180-210-250-280
	24.99	112	1985	24	56	2381	14.6	36.0	2380	9.4	90-100-112-132-160	132	180-210-250
	27.16	103	2158	24	52	2587	14.5	33.1	2586	9.3	90-100-112-132-160	132	180-210-250
	30.24	93	2059	21	46.3	2463	12.4	29.8	2461	8.0	90-100-112-132-160	132	180-210-250
	32.50	86	2582	24	43.1	3096	14.5	27.7	3095	9.3	90-100-112-132-160	132	180-210-250
36.18	77	2464	21	38.7	2947	12.4	24.9	2945	8.0	90-100-112-132-160	132	180-210-250	
39.79	70	2438	18.7	35.2	2920	11.2	22.6	2921	7.2	90-100-112-132-160	132	180-210-250	
44.29	63	2455	16.9	31.6	2941	10.1	20.3	2944	6.5	90-100-112-132-160	132	180-210-250	
603	46.60	60	2785	18.8	30.0	3333	11.3	19.3	3333	7.2	80-90-100-112-132-160	132	180-210-250
	55.80	50	2715	15.3	25.1	3244	9.2	16.1	3247	5.9	80-90-100-112-132-160	132	180-210-250
	60.10	46.6	2793	14.7	23.3	3340	8.8	15.0	3340	5.6	80-90-100-112-132-160	132	180-210-250
	71.90	38.9	2705	11.9	19.5	3251	7.1	12.5	3253	4.6	80-90-100-112-132-160	132	180-210-250
	88.00	31.8	2560	9.2	15.9	3055	5.5	10.2	3056	3.5	80-90-100-112-132-160	132	180-210-250
	96.30	29.1	2801	9.2	14.5	3355	5.5	9.3	3353	3.5	80-90-100-112-132-160	132	180-210-250
	115.20	24.3	2732	7.5	12.2	3264	4.5	7.8	3264	2.9	80-90-100-112-132-160	132	180-210-250
	136.50	20.5	2787	6.4	10.3	3339	3.9	6.6	3342	2.5	80-90-100-112-132-160	132	180-210-250
	148.30	18.9	2813	6.0	9.4	3366	3.6	6.1	3369	2.3	80-90-100-112-132-160	132	180-210-250
	177.50	15.8	2760	4.9	7.9	3310	2.9	5.1	3316	1.9	80-90-100-112-132-160	132	180-210-250
	190.40	14.7	2805	4.6	7.4	3359	2.8	4.7	3371	1.8	80-90-100-112	—	180
	207.00	13.5	2898	4.4	6.8	3467	2.6	4.3	3460	1.7	80-90-100-112	—	180
	217.20	12.9	2678	3.9	6.4	3200	2.3	4.1	3204	1.5	80-90-100-112	—	180
	247.60	11.3	2881	3.7	5.7	3444	2.2	3.6	3458	1.4	80-90-100-112	—	180
	303.10	9.2	2721	2.8	4.6	3258	1.7	3.0	3249	1.1	80-90-100-112	—	180

DIMENSIONI / DIMENSIONS / ABMESSUNGEN / DIMENSIONS / DIMENSIONES / DIMENSÕES

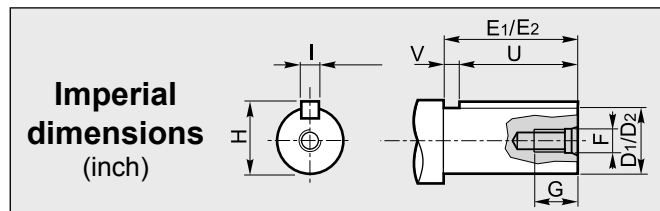
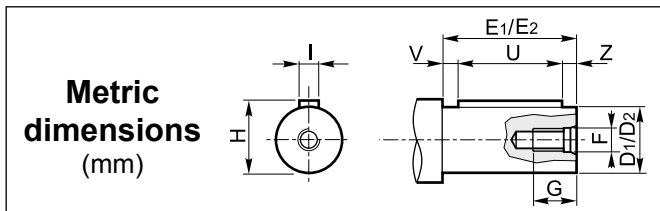

1 **Albero entrata / Input shaft / Antriebswelle**
Arbre d'entrée / Eje de entrada / Eixo de entrada

CV RCV	D ₁	E ₁	F	G	H	I	U	V	Z
602	38	80	M12	25	41	10	70	5	5
603									

2 **Albero uscita / Output shaft / Abtriebswelle**
Arbre de sortie / Eje de salida / Eixo de saída

CV RCV	D ₂	E	F	G	H	I	U	V
602	60.32 (2.375)	120 (4.724)	3/4-10	50 (1.969)	67.20 (2.647)	15.87 (0.625)	88.90 (3.500)	31.10 (1.224)
603								

(Inch)

2 **Albero uscita / Output shaft / Abtriebswelle**
Arbre de sortie / Eje de salida / Eixo de saída

CV RCV	D ₂	E	F	G	H	I	U	V	Z
602	60	120	M20	50	64	18	100	10	10
603	65	120	M20	50	69	18	100	10	10
	70	140	M20	50	74.5	20	120	10	10

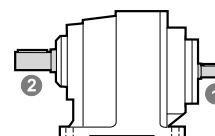

A richiesta / On request / Auf Anfrage / Sur demande / Bajo demanda / Sob consulta

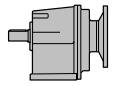

DIMENSIONI / DIMENSIONS / ABMESSUNGEN / DIMENSIONS / DIMENSIONES / DIMENSÕES

P

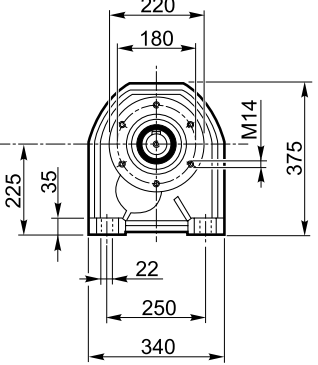
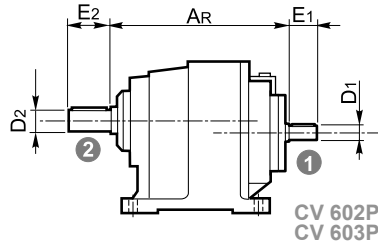
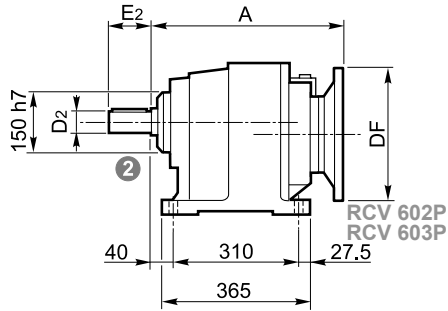

N

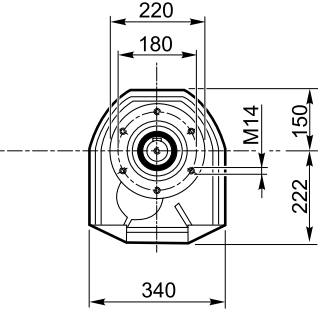
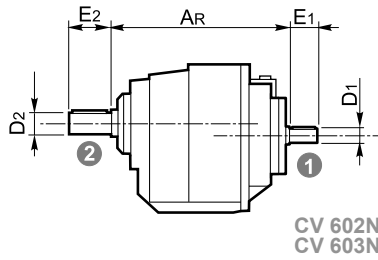
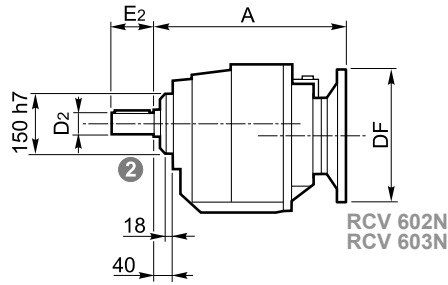

NF

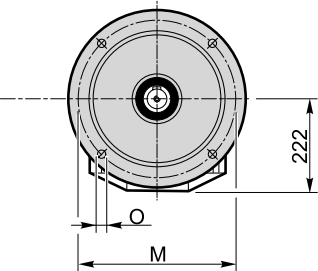
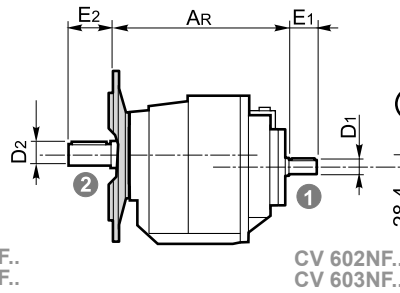
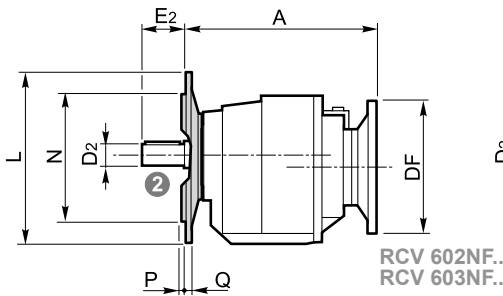

PF

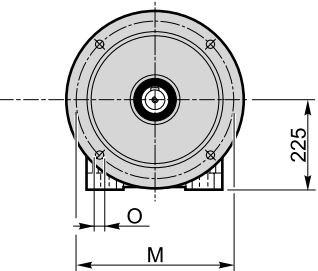
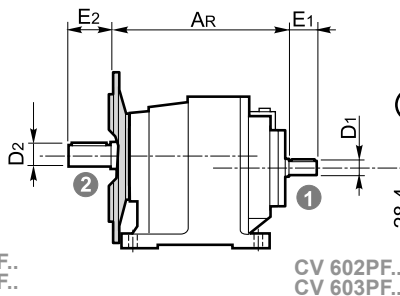
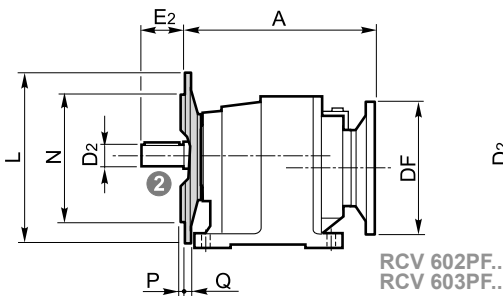

RCV CV	RCV							CV
	IEC	DF		A	NEMA	DF	A	
		(B5)	(B14)					
602	90	200		410	180	228.6	421	405
	100	250			210	228.6	421	
	112	250			250	228.6	421	
	132	300	200	430	280	285.8	437	
	160	350						
	180	350						
603	200	400		445				425
	80	200		430	180	228.6	441	
	90	200			210	228.6	441	
	100	250			250	228.6	441	
	112	250		450				
	132	300	200					
160	350							

	L	M	N	O	P	Q
NF350 - PF350	350	250	300	18	5	17