

DATI TECNICI / TECHNICAL DATA / TECHNISCHE DATEN
 CARACTÉRISTIQUES TECHNIQUES / DATOS TÉCNICOS / CARACTERÍSTICAS TÉCNICAS

CV RCV	i	n ₁ = 2800 min ⁻¹			n ₁ = 1400 min ⁻¹			n ₁ = 900 min ⁻¹					
		n ₂ min ⁻¹	Mn ₂ Nm	P ₁ kW	n ₂ min ⁻¹	Mn ₂ Nm	P ₁ kW	n ₂ min ⁻¹	Mn ₂ Nm	P ₁ kW	IEC B5	IEC B14	NEMA
202	5.49	510	61	3.4	255	73	2.0	164	73	1.3	63-71-80-90	90	56-140
	6.46	433	59	2.8	217	70	1.7	139	70	1.1	63-71-80-90	90	56-140
	7.75	361	60	2.4	181	72	1.4	116	73	0.92	63-71-80-90	90	56-140
	8.57	327	61	2.2	163	73	1.3	105	73	0.84	63-71-80-90	90	56-140
	9.92	282	64	2.0	141	77	1.2	91	77	0.76	63-71-80-90	90	56-140
	11.67	240	65	1.7	120	78	1.0	77	78	0.66	63-71-80-90	90	56-140
	14.00	200	65	1.4	100	78	0.85	64	78	0.55	63-71-80-90	90	56-140
	15.48	181	65	1.3	90	78	0.77	58	78	0.49	63-71-80-90	90	56-140
	18.01	155	81	1.4	78	97	0.82	50	97	0.53	63-71-80-90	90	56-140
	21.19	132	80	1.2	66	96	0.69	42.5	96	0.44	63-71-80-90	90	56-140
	25.43	110	88	1.1	55	106	0.64	35.4	106	0.41	63-71-80-90	90	56-140
	28.13	100	86	0.93	50	103	0.56	32.0	103	0.36	63-71-80-90	90	56-140
	31.71	88	89	0.86	44.2	108	0.52	28.4	107	0.33	63-71-80-90	90	56-140
	37.31	75	90	0.74	37.5	107	0.44	24.1	107	0.28	63-71-80-90	90	56-140
	44.77	63	89	0.61	31.3	107	0.37	20.1	107	0.23	63-71-80-90	90	56-140
49.52	57	87	0.54	28.3	104	0.32	18.2	104	0.21	63-71-80-90	90	56-140	
203	58.10	48.2	89	0.48	24.1	107	0.29	15.5	107	0.19	63-71	63-71	56
	64.30	43.5	87	0.43	21.8	104	0.26	14.0	104	0.16	63-71	63-71	56
	69.20	40.5	91	0.41	20.2	109	0.25	13.0	108	0.16	63-71	63-71	56
	81.40	34.4	90	0.35	17.2	108	0.21	11.1	108	0.13	63-71	63-71	56
	97.70	28.7	90	0.29	14.3	107	0.17	9.2	108	0.11	63-71	63-71	56
	108.10	25.9	87	0.25	13.0	105	0.15	8.3	104	0.10	63-71	63-71	56
	120.10	23.3	91	0.24	11.7	109	0.14	7.5	109	0.09	63-71	63-71	56
	141.30	19.8	91	0.20	9.9	108	0.12	6.4	108	0.08	63-71	63-71	56
	169.50	16.5	91	0.17	8.3	108	0.10	5.3	108	0.06	63-71	63-71	56
	187.50	14.9	89	0.15	7.5	107	0.09	4.8	107	0.06	63-71	63-71	56

DIMENSIONI / DIMENSIONS / ABMESSUNGEN / DIMENSIONS / DIMENSIONES / DIMENSÕES

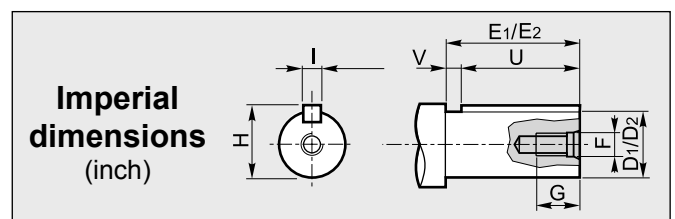
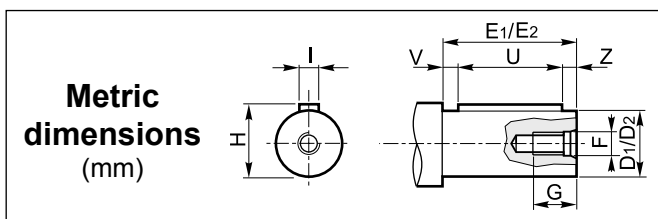

1 **Albero entrata / Input shaft / Antriebswelle**
 Arbre d'entrée / Eje de entrada / Eixo de entrada

CV	D ₁	E ₁	F	G	H	I	U	V	Z
202	19	40	M6	15	21.5	6	30	5	5
203	16	40	M6	15	18	5	25	10	5

2 **Albero uscita / Output shaft / Abtriebswelle**
 Arbre de sortie / Eje de salida / Eixo de saída

CV RCV	D ₂	E	F	G	H	I	U	V
202	19.05	40	5/16-18	18	21.14	4.76	25.4	14.6
203	(0.750)	(1.575)		(0.709)	(0.832)	(0.188)	(1.000)	(0.575)

(Inch)

2 **Albero uscita / Output shaft / Abtriebswelle**
 Arbre de sortie / Eje de salida / Eixo de saída

CV RCV	D ₂	E	F	G	H	I	U	V	Z	
202	14	30	M5	12	16	5	20	5	5	
	16	40	M6	16	18	5	30	5	5	
	19	40	M6	16	21.5	6	30	5	5	
	20	40	M8	18	22.5	6	30	5	5	
	203	24	40	M8	18	27	8	30	5	5
		25	40	M8	18	28	8	30	5	5
28		60	M8	18	31	8	50	5	5	
30	60	M10	22	33	8	50	5	5		

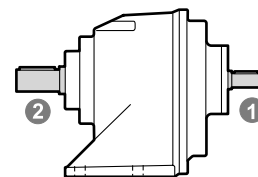

A richiesta / On request / Auf Anfrage / Sur demande / Bajo demanda / Sob consulta

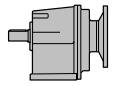

DIMENSIONI / DIMENSIONS / ABMESSUNGEN / DIMENSIONS / DIMENSIONES / DIMENSÕES

P

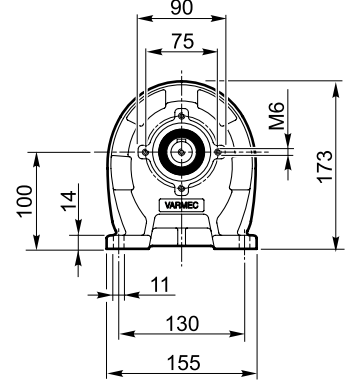
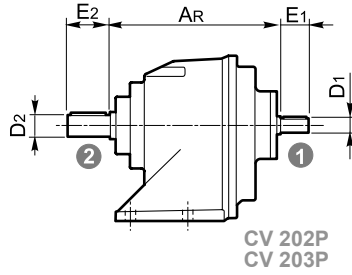
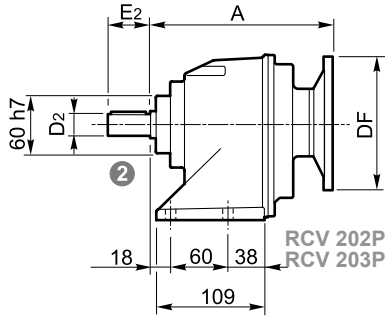

N

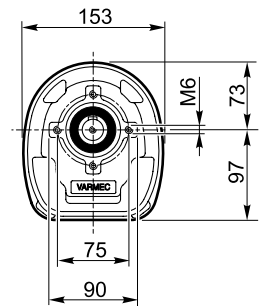
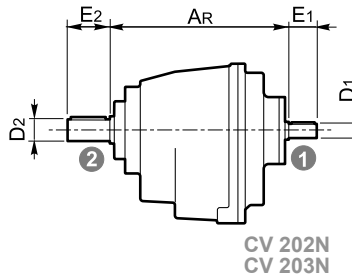
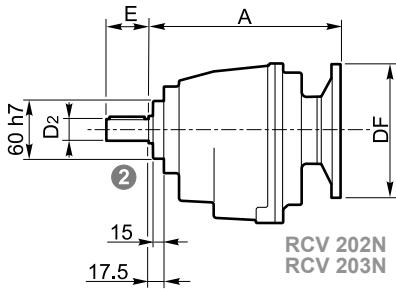

NF

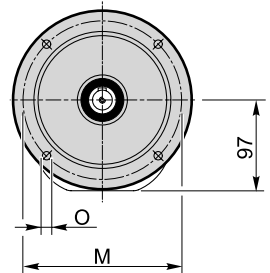
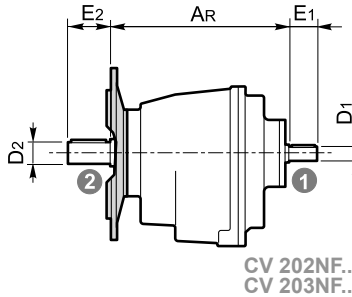
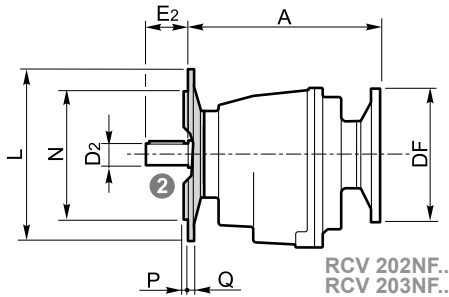

PF

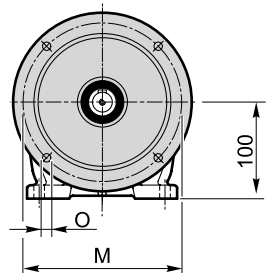
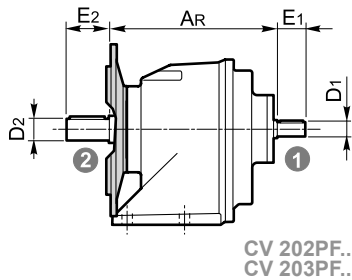
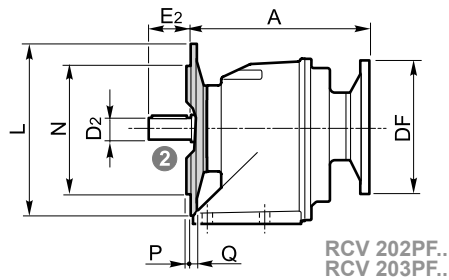

RCV CV	RCV						CV	
	IEC	DF		A	NEMA	DF	A	AR
(B5)		(B14)						
202	63	140		180	56	165.1	188	173
	71	160			140	165.1	188	
	80	200						
	90	200	140					
203	63	140	90	173.2	56	165.1	192.2	170
	71	160	105					

	L	M	N	O	P	Q
NF120 - PF120	120	100	80	7	2.5	10
NF140 - PF140	140	115	95	9	3	10
NF160 - PF160	160	130	110	11	3	10
NF200	200	165	130	11	3	10