

CATENE e GUIDA CATENE

CATENE A RULLI TPM[®]	pag. 2
CATENE A RULLI QRC[®]	pag. 4
CATENE A RULLI CRT[®]	pag. 10
GUIDA CATENE	pag. 14



GIUNTO



FALSA



CATENE PRODOTTE DA
AZIENDA CERTIFICATA
ISO 9001

Confezioni da 10m e 100m

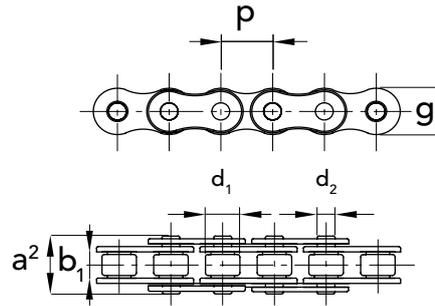

f = superficie resistente

SEMPLICE

ISO N.	CODICE CATENA	CODICE GIUNTO	CODICE FALSA	P		b ₁ min. mm	d ₂ mm	d ₁ max mm	a ² max mm	g max mm	f cm ²	caric. rott. N. mm ²	kg/m =
				mm	inch								
081-1	70110008	70110058	70110088	12,7	1/2"	3,3	3,59	7,75	10,2	9,9	0,2	7200	0,28
083-1	70111008	70111058	70111088	12,7	1/2"	4,88	4,09	7,75	12,9	10,3	0,32	9200	0,42
084-1	70171008	70171058	70171088	12,7	1/2"	4,88	4,09	7,75	14,8	11,15	0,35	11000	0,59
084-1	72171008	-	-	12,7	1/2"	-	-	7,75	-	-	-	-	-

N.B. Tutte le catene TPM® sono sottoposte a pre-tensionamento di 2/3 rispetto al carico di rottura minimo per stabilizzarne dimensioni e allungamento.

Disegni CAD disponibili sul sito
www.chiaravalli.com

Quantità, disponibilità e prezzi
con B2B Chiaravalli



CATENE A RULLI SERIE EUROPEA E AMERICANA QRC®



**FALSA
SEMPLICE**



(*)

GIUNTO

SEMPLICE - MOLLETTA



(◆)

GIUNTO

SEMPLICE - COPPIGLIA



**FALSA
DOPPIA**



**GIUNTO
DOPPIO**



**FALSA
TRIPLA**



**GIUNTO
TRIPLO**

(*) GIUNTI con MOLLETTA

(*) GIUNTI con MOLLETTA
(◆) e/o COPPIGLIA

(◆) GIUNTI con COPPIGLIA

da 04 (B1, B2 e B3)
a 12 (B1, B2 e B3)

16 (B1, B2 e B3)

da 20 (B1, B2 e B3)
a 32 (B1, B2 e B3)



CATENE PRODOTTE DA
AZIENDA CERTIFICATA
ISO 9001

Confezioni da 5m

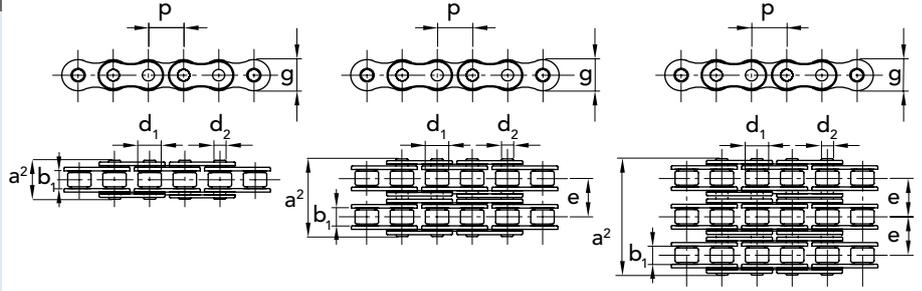

f = superficie resistente

SEMPLICE

ISO N.	CODICE	CODICE GIUNTO	CODICE FALSA	P		b ₁	d ₂	d ₁	a ²	g	f	caric. rott.	kg/m
				mm	inch	min. mm	mm	max mm	max mm	max mm	cm ²	N. mm ²	=
04 B-1	70106007	70106057	70106087	6	-	2,80	1,85	4	7,4	5	0,07	2800	0,12
05 B-1	70108007	70108057	70108087	8	-	3,00	2,31	5	8,6	7,11	0,11	4700	0,18
06 B-1	70109007	70109057	70109087	9,525	3/8"	5,72	3,28	6,35	13,5	8,26	0,28	8200	0,4
08 B-1	70112007	70112057	70112087	12,7	1/2"	7,75	4,45	8,51	17	11,81	0,5	16400	0,68
10 B-1	70115007	70115057	70115087	15,875	5/8"	9,65	5,08	10,16	19,6	14,73	0,67	20500	0,91
12 B-1	70119007	70119057	70119087	19,05	3/4"	11,68	5,72	12,07	22,7	16,13	0,89	26500	1,12
16 B-1	70125007	70125057	70125087	25,40	1"	17,02	8,28	15,88	36,1	21,08	2,1	52500	2,59
20 B-1	70131007	70131057	70131087	31,75	1 1/4"	19,56	10,19	19,05	43,2	26,42	2,95	85500	3,68
24 B-1	70138007	70138057	70138087	38,1	1 1/2"	25,40	14,63	25,4	53,4	33,4	5,54	153900	6,85
28 B-1	70144007	70144057	70144087	44,45	1 3/4"	30,99	15,9	17,94	65,1	37,08	7,4	180000	8,56
32 B-1	70150007	70150057	70150087	50,8	2"	38,10	17,81	29,21	67,4	42,29	8,11	230000	9,49

DOPPIA

ISO N.	CODICE	CODICE GIUNTO	CODICE FALSA	P		b ₁	d ₂	d ₁	a ²	g	e	f	caric. rott.	kg/m
				mm	inch	min. mm	mm	max mm	max mm	max mm	mm	cm ²	N. mm ²	=
06 B-2	70209007	70209057	70209087	9,525	3/8"	5,72	3,28	6,35	23,8	8,26	10,24	0,55	15500	0,76
08 B-2	70212007	70212057	70212087	12,7	1/2"	7,75	4,45	8,51	31	11,81	13,92	1	28500	1,31
10 B-2	70215007	70215057	70215087	15,875	5/8"	9,65	5,08	10,16	36,2	14,73	16,59	1,34	41000	1,79
12 B-2	70219007	70219057	70219087	19,05	3/4"	11,68	5,72	12,07	42,2	16,13	19,46	1,78	53000	2,22
16 B-2	70225007	70225057	70225087	25,40	1"	17,02	8,28	15,88	68	21,08	31,88	4,21	99500	5,03
20 B-2	70231007	70231057	70231087	31,75	1 1/4"	19,56	10,19	19,05	79,7	26,42	35,45	5,91	162000	7,33
24 B-2	70238007	70238057	70238087	38,1	1 1/2"	25,40	14,63	25,4	101,8	33,4	48,36	11,09	293000	13,5
28 B-2	70244007	70244057	70244087	44,45	1 3/4"	30,99	15,9	17,94	124,7	37,08	59,56	14,81	344000	16,96
32 B-2	70250007	70250057	70250087	50,8	2"	30,99	17,81	29,21	126	42,29	58,55	16,23	440000	18,74

TRIPLA

ISO N.	CODICE	CODICE GIUNTO	CODICE FALSA	P		b ₁	d ₂	d ₁	a ²	g	e	f	caric. rott.	kg/m
				mm	inch	min. mm	mm	max mm	max mm	max mm	mm	cm ²	N. mm ²	=
06 B-3	70309007	70309057	70309087	9,525	3/8"	5,72	3,28	6,35	34	8,26	10,24	0,83	22800	1,12
08 B-3	70312007	70312057	70312087	12,7	1/2"	7,75	4,45	8,51	44,9	11,81	13,92	1,5	41000	1,94
10 B-3	70315007	70315057	70315087	15,875	5/8"	9,65	5,08	10,16	52,8	14,73	16,59	2,02	61500	2,68
12 B-3	70319007	70319057	70319087	19,05	3/4"	11,68	5,72	12,07	61,7	16,13	19,46	2,68	80000	3,32
16 B-3	70325007	70325057	70325087	25,40	1"	17,02	8,28	15,88	99,9	21,08	31,88	6,32	149000	7,65
20 B-3	70331007	70331057	70331087	31,75	1 1/4"	19,56	10,19	19,05	116,1	26,42	35,45	8,86	244000	10,96
24 B-3	70338007	70338057	70338087	38,1	1 1/2"	25,40	14,63	25,4	150,2	33,4	48,36	16,64	438000	20,2
28 B-3	70344007	70344057	70344087	44,45	1 3/4"	30,99	15,9	17,94	184,3	37,08	59,56	22,21	516000	25,38
32 B-3	70350007	70350057	70350087	50,8	2"	30,99	17,81	29,21	184,5	42,29	58,55	24,34	671000	28,04

N.B. Tutte le catene QRC® sono sottoposte a pre-tensionamento di 2/3 rispetto al carico di rottura minimo per stabilizzarne dimensioni e allungamento.

Disegni CAD disponibili sul sito
www.chiaravalli.com

Quantità, disponibilità e prezzi
con B2B Chiaravalli





CATENE PRODOTTE DA
AZIENDA CERTIFICATA
ISO 9001

Confezioni da 5m

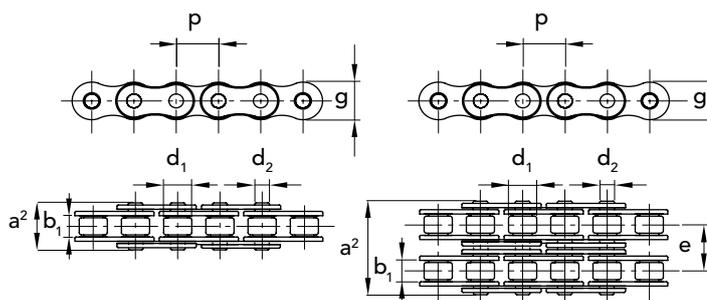

f = superficie resistente

SEMPLICE ACCIAIO INOX AISI 304

ISO N.	CODICE CATENA	CODICE GIUNTO	CODICE FALSA	P	b ₁	d ₂	d ₁	a ²	g	e	f	caric. rott.	kg/m	
				mm	inch	min. mm	mm	max mm	max mm	max mm	mm	cm ²	N. mm ²	=
05 B-1	74108007	74108057	74108087	8,00	-	3	2,31	5	8,6	7,11	0,11	0,18	3400	0,18
06 B-1	74109007	74109057	74109087	9,53	3/8"	5,72	3,28	6,35	13,5	8,26	0,28	0,41	4400	0,4
08 B-1	74112007	74112057	74112087	12,70	1/2"	7,75	4,45	8,51	17	11,81	0,5	0,7	9800	0,68
10 B-1	74115007	74115057	74115087	15,88	5/8"	9,65	5,08	10,16	19,6	14,73	0,67	0,95	13600	0,91
12 B-1	74119007	74119057	74119087	19,05	3/4"	11,68	5,72	12,07	22,7	16,13	0,89	1,25	15000	1,12
16 B-1	74125007	74125057	74125087	25,40	1"	17,02	8,28	15,88	36,1	21,08	2,1	2,7	39500	2,59

DOPPIA ACCIAIO INOX AISI 304

ISO N.	CODICE CATENA	CODICE GIUNTO	CODICE FALSA	P	b ₁	d ₂	d ₁	a ²	g	e	f	caric. rott.	kg/m	
				mm	inch	min. mm	mm	max mm	max mm	max mm	mm	cm ²	N. mm ²	=
06 B-2	74209007	74209057	74209087	9,53	3/8"	5,72	3,28	6,35	23,8	8,26	10,24	0,55	8400	1,35
08 B-2	74212007	74212057	74212087	12,70	1/2"	7,75	4,45	8,51	31	11,81	13,92	1	16950	1,85
10 B-2	74215007	74215057	74215087	15,88	5/8"	9,65	5,08	10,16	36,2	14,73	16,59	1,34	27000	2,5
12 B-2	74219007	74219057	74219087	19,05	3/4"	11,68	5,72	12,07	42,2	16,13	19,46	1,78	29700	5,4
16 B-2	74225007	74225057	74225087	25,40	1"	17,02	8,28	15,88	68	21,08	31,88	4,21	69000	0,78

SEMPLICE NICHELATA

ISO N.	CODICE CATENA	CODICE GIUNTO	CODICE FALSA	P	b ₁	d ₂	d ₁	a ²	g	f	caric. rott.	kg/m	
				mm	inch	min. mm	mm	max mm	max mm	max mm	cm ²	N. mm ²	=
06 B-1	73109007	73109057	73109087	9,53	3/8"	5,72	3,28	6,35	13,5	8,26	0,28	8200	0,41
08 B-1	73112007	73112057	73112087	12,70	1/2"	7,75	4,45	8,51	17	11,81	0,5	16400	0,7
10 B-1	73115007	73115057	73115087	15,88	5/8"	9,65	5,08	10,16	19,6	14,73	0,67	20500	0,95
12 B-1	73119007	73119057	73119087	19,05	3/4"	11,68	5,72	12,07	22,7	16,13	0,89	26500	1,25
16 B-1	73125007	73125057	73125087	25,40	1"	17,02	8,28	15,88	36,1	21,08	2,1	52500	2,7

N.B. Tutte le catene QRC® sono sottoposte a pre-tensionamento di 2/3 rispetto al carico di rottura minimo per stabilizzarne dimensioni e allungamento.



Disegni CAD disponibili sul sito
www.chiaravalli.com

Quantità, disponibilità e prezzi
con B2B Chiaravalli



CATENE PRODOTTE DA AZIENDA CERTIFICATA ISO 9001

N.B. Tutte le catene QRC® sono sottoposte a pre-tensionamento di 2/3 rispetto al carico di rottura minimo per stabilizzarne dimensioni e allungamento.

Confezioni da 5m

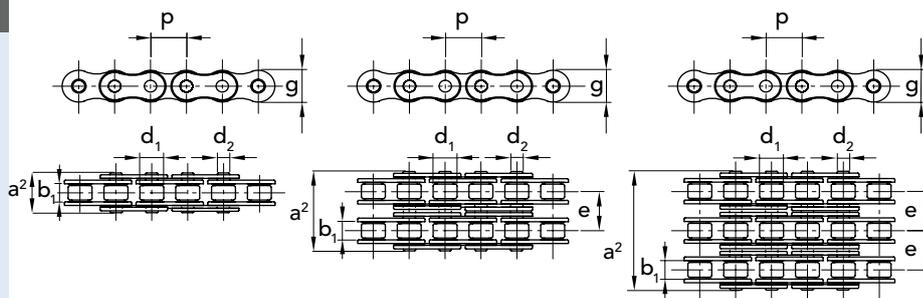

f = superficie resistente

CATENE A RULLI SERIE AMERICANA QRC®

SEMPLICE "ANSI" ASA

ANSI N.	CODICE CATENA	CODICE GIUNTO	CODICE FALSA	P		b ₁ min. mm	d ₂ mm	d ₁ max mm	a ² max mm	g max mm	f cm ²	caric. rott. N. mm ²	kg/m =
				mm	inch								
35-1	71103007	71103057	71103087	9,525	3/8"	4,77	3,58	5,08	13,2	9,05	0,27	7350	0,34
40-1	71104007	71104057	71104087	12,7	1/2"	7,95	3,96	7,92	17,8	12,07	0,44	12900	0,63
50-1	71105007	71105057	71105087	15,875	5/8"	9,53	5,08	10,16	21,8	15,09	0,7	20200	1,04
60-1	71106007	71106057	71106087	19,05	3/4"	12,7	5,94	11,91	26,9	18,08	1,06	28900	1,52
80-1	71108007	71108057	71108087	25,40	1"	15,88	7,92	15,88	33,5	24,13	1,79	51300	2,58
100-1	71110007	71110057	71110087	31,75	1 1/4"	19,05	9,53	19,05	41,1	30,18	2,62	80200	3,85
120-1	71112007	71112057	71112087	38,1	1 1/2"	25,4	11,1	22,23	50,8	36,2	3,94	115000	5,61
140-1	71114007	71114057	71114087	44,45	1 3/4"	25,4	12,7	25,4	54,9	42,24	4,72	156300	7,24
160-1	71116007	71116057	71116087	50,8	2"	31,75	14,27	28,58	65,5	48,26	6,5	205500	9,91

DOPPIA "ANSI" ASA

ANSI N.	CODICE CATENA	CODICE GIUNTO	CODICE FALSA	P		b ₁ min. mm	d ₂ mm	d ₁ max mm	a ² max mm	g max mm	e mm	f cm ²	caric. rott. N. mm ²	kg/m =
				mm	inch									
35-2	71203007	71203057	71203087	9,525	3/8"	4,77	3,58	5,08	21,6	9,05	10,13	0,54	14700	0,67
40-2	71204007	71204057	71204087	12,7	1/2"	7,95	3,96	7,92	32,3	12,07	14,38	0,88	25600	1,26
50-2	71205007	71205057	71205087	15,875	5/8"	9,53	5,08	10,16	39,9	15,09	18,11	1,4	40400	2,05
60-2	71206007	71206057	71206087	19,05	3/4"	12,7	5,94	11,91	49,8	18,08	22,78	2,12	57800	3,01
80-2	71208007	71208057	71208087	25,40	1"	15,88	7,92	15,88	62,7	24,13	29,29	3,58	102700	2,13
100-2	71210007	71210057	71210087	31,75	1 1/4"	19,05	9,53	19,05	77	30,18	35,76	5,24	160400	7,64
120-2	71212007	71212057	71212087	38,1	1 1/2"	25,4	11,1	22,23	96,3	36,2	45,44	7,88	230000	11,13
140-2	71214007	71214057	71214087	44,45	1 3/4"	25,4	12,7	25,4	103,6	42,24	48,87	9,44	312600	14,37
160-2	71216007	71216057	71216087	50,8	2"	31,75	14,27	28,58	124,2	48,26	58,55	13	411000	19,68

TRIPLA "ANSI" ASA

ANSI N.	CODICE CATENA	CODICE GIUNTO	CODICE FALSA	P		b ₁ min. mm	d ₂ mm	d ₁ max mm	a ² max mm	g max mm	e mm	f cm ²	caric. rott. N. mm ²	kg/m =
				mm	inch									
35-3	71303007	71303057	71303087	9,525	3/8"	4,77	3,58	5,08	31,8	9,05	10,13	0,81	22050	0,99
40-3	71304007	71304057	71304087	12,7	1/2"	7,95	3,96	7,92	46,7	12,07	14,38	1,32	38300	1,98
50-3	71305007	71305057	71305087	15,875	5/8"	9,53	5,08	10,16	57,9	15,09	18,11	2,1	60600	3,06
60-3	71306007	71306057	71306087	19,05	3/4"	12,7	5,94	11,91	72,6	18,08	22,78	3,18	86700	4,5
80-3	71308007	71308057	71308087	25,40	1"	15,88	7,92	15,88	91,7	24,13	29,29	5,37	154100	7,67
100-3	71310007	71310057	71310087	31,75	1 1/4"	19,05	9,53	19,05	113	30,18	35,76	7,86	240600	11,43
120-3	71312007	71312057	71312087	38,1	1 1/2"	25,4	11,1	22,23	141,7	36,2	45,44	11,82	345000	16,67
140-3	71314007	71314057	71314087	44,45	1 3/4"	25,4	12,7	25,4	152,4	42,24	48,87	14,16	468900	21,51
160-3	71316007	71316057	71316087	50,8	2"	31,75	14,27	28,58	182,9	48,26	58,55	19,5	616400	29,45

SEMPLICE RINFORZATA

ANSI N.	CODICE CATENA	CODICE GIUNTO	CODICE FALSA	P		b ₁ min. mm	d ₂ mm	d ₁ max mm	a ² max mm	g max mm	f cm ²	caric. rott. N. min.	kg/m =
				mm	inch								
60-H1	72906007	72906057	72906087	19,05	3/4"	12,7	5,94	11,91	28,9	18,08	1,06	49000	1,7
80-H1	72908007	72908057	72908087	25,40	1"	15,88	7,92	15,88	36,5	24,13	1,79	84800	2,9

Disegni CAD disponibili sul sito
www.chiaravalli.com

Quantità, disponibilità e prezzi
con B2B Chiaravalli



CATENE PRODOTTE DA
AZIENDA CERTIFICATA
ISO 9001

Confezioni da 5m

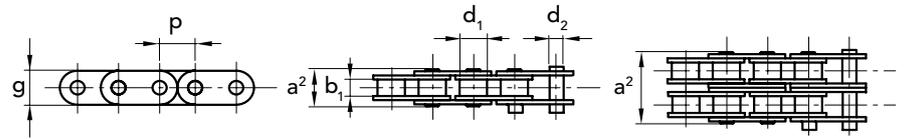

f = superficie resistente

A PIASTRE DIRITTE

ISO N.	CODICE CATENA	CODICE GIUNTO	CODICE FALSA	P		b ₁ min. mm	d ₂ mm	d ₁ max mm	a ² max mm	g max mm	f cm ²	caric. rott. N. mm ²	kg/m =
				mm	inch								
08B1	74112607	74112657	74112687	12,70	1/2"	7,75	4,45	8,51	17,0	11,81	0,5	17000	0,8
10B1	74115607	74115657	74115687	15,875	5/8"	9,65	5,08	10,16	19,6	14,73	0,67	22000	1,0
10B2	74215607	74215657	74215687	15,88	5/8"	9,65	5,08	10,16	36,2	14,73	1,34	27000	2,5
12B1	74119607	74119657	74119687	19,05	3/4"	11,68	5,72	12,07	22,7	16,13	0,89	28000	1,3
12B2	74219607	74219657	74219687	19,05	3/4"	11,68	5,72	12,07	42,2	16,13	1,78	60000	2,6
16B1	74125607	74125657	74125687	25,40	1"	11,02	8,28	15,88	36,1	21,08	2,10	57000	2,9

N.B. Tutte le catene QRC® sono sottoposte a pre-tensionamento di 2/3 rispetto al carico di rottura minimo per stabilizzarne dimensioni e allungamento.

Disegni CAD disponibili sul sito
www.chiaravalli.com

Quantità, disponibilità e prezzi
con B2B Chiaravalli





CATENE PRODOTTE DA
AZIENDA CERTIFICATA
ISO 9001

Confezioni da 5m

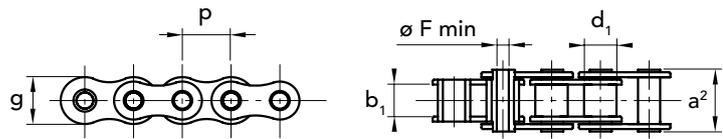

f = superficie resistente

A PERNI FORATI

RIFERIM. N.	CODICE CATENA	CODICE GIUNTO	CODICE FALSA	P		b ₁ min. mm	d ₁ mm	a ² max mm	Ø F max mm	g max mm	f cm ²	caric. rott. N. mm ²	kg/m =
				mm	inch								
08 BHP-1	74112707	74112757	74112787	12,7	1/2"	7,75	8,51	17,00	4,4	11,7	0,7	13.500	0,5
10 BHP-1	74115707	74115757	74115787	15,875	5/8"	9,65	10,16	21,00	5,1	14	1,0	20.000	0,8

N.B. Tutte le catene QRC® sono sottoposte a pre-tensionamento di 2/3 rispetto al carico di rottura minimo per stabilizzarne dimensioni e allungamento.

Disegni CAD disponibili sul sito
www.chiaravalli.com

Quantità, disponibilità e prezzi
con B2B Chiaravalli





GIUNTO

2 ATTACCHI



GIUNTO

1 ATTACCO



GIUNTO

PERNI FORATI



GIUNTO

PERNI PIENI



GIUNTO

PERNO SPORGENTE



CATENE PRODOTTE DA
AZIENDA CERTIFICATA
ISO 9001

Confezioni da 5m

f = superficie resistente

A PERNI PIENI

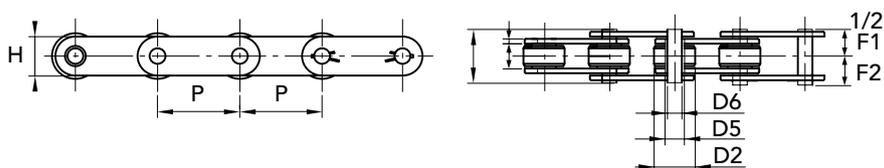

CATENE TRASPORTO CRT®

CATENA	CODICE CATENA	CODICE GIUNTO	P mm	L mm	D2 mm	D5 mm	D6 mm	H mm	S mm	F1 mm	F2 mm	caric. rott. N. mm ²	kg.m catena
1,1205	74502050	74502055	50	11,5	25	8,35	5,7	18	2,5	25,5	15,4	18000	1,7
1,1206	74502060	74502065	50	11,5	25	11	8	20	3	28,8	16,5	22000	7,9
1,1400	74504000	74504005	50	15	31	13,2	10	23	3	32,6	19,2	32000	3
1,1500	74505000	74505005	50	15	31	13,2	10	25	4	36,6	20,7	40000	3,9
1,1505	74505020	74505025	100	15	31	13,2	10	25	4	36,6	20,7	40000	2,7
1,1703	74507030	74507035	100	22	40	17	12	35	4	44	25	75000	4,9

A PERNI PIENI TIPO "B"

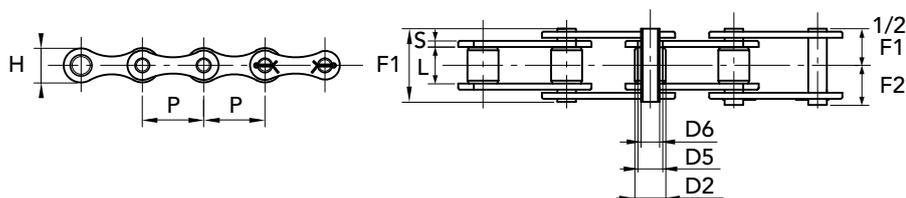

CATENA	CODICE CATENA	CODICE GIUNTO	P mm	L mm	D2 mm	D5 mm	D6 mm	H mm	S mm	F1 mm	F2 mm	caric. rott. N. mm ²	kg.m catena
1,1400 B	74514000	74514005	50	15	31	13,2	10	23	3	32,6	19,2	32000	2,5

A PERNI PIENI CON ATTACCHI

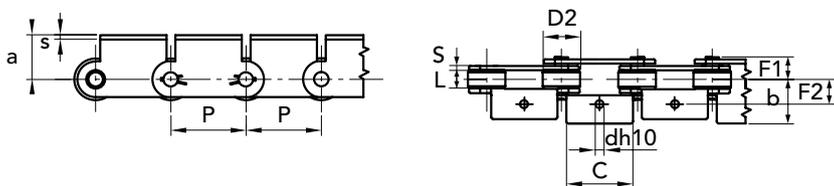

CATENA	CODICE CATENA	CODICE GIUNTO	P mm	D2 mm	a mm	b mm	c mm	d mm	e mm	s mm	L mm	F2 mm	caric. rott. N. mm ²	kg.m attacco
1.1205 A1-01	74522050	74522055	50	25	24	22	46	6,5	36	2,5	11,5	12,75	18000	0,035

Disegni CAD disponibili sul sito
www.chiaravalli.com

Quantità, disponibilità e prezzi
con B2B Chiaravalli



CATENE PRODOTTE DA
AZIENDA CERTIFICATA
ISO 9001

Confezioni da 5m

f = superficie resistente

A PERNI PIENI CON ATTACCHI

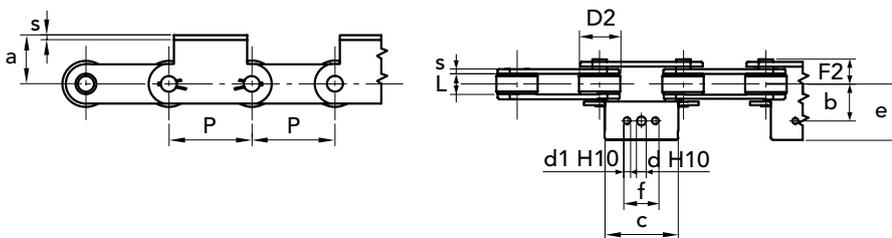

CATENA	CODICE CATENA	CODICE GIUNTO	P mm	D2 mm	a mm	b mm	c mm	d mm	e mm	s mm	d1 mm	f mm	L mm	F2 mm	caric. rott. N. mm ²	kg.m
1.1205 A1-02	74532050	74522055	50	25	24	22	46	6,5	36	2,5	-	-	11,5	12,75	18000	0,035
1.1400 A3-02	74534000	74534005	50	31	35	31	60	10,5	48,5	3	8,5	25	15	16,3	32000	0,05
1.1500 A3-02	74535000	74535005	50	31	35	32	45	10,5	48	4	8,5	25	15	18,7	40000	0,07

A PERNI PIENI CON ATTACCHI

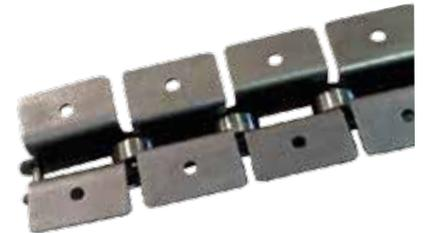
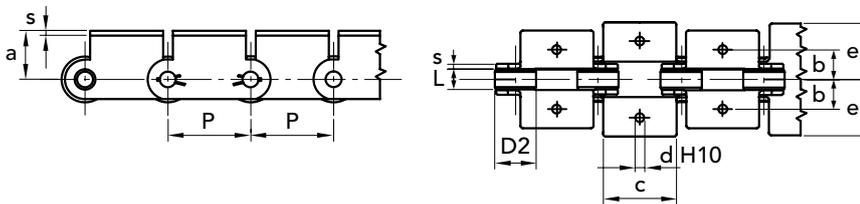

CATENA	CODICE CATENA	CODICE GIUNTO	P mm	D2 mm	a mm	b mm	c mm	d mm	e mm	s mm	L mm	caric. rott. N. mm ²	kg.m
1.1205 K1-01	74542050	74542055	50	25	24	22	46	6,5	36	2,5	11,5	18000	0,035

A PERNI PIENI CON ATTACCHI

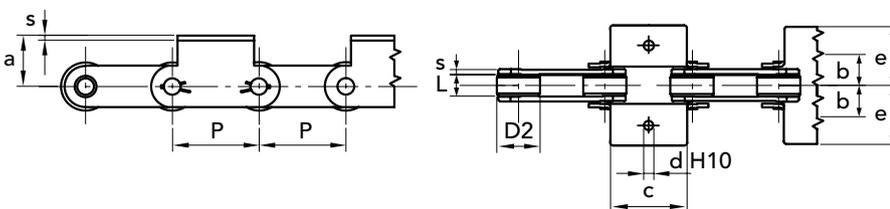

CATENA	CODICE CATENA	CODICE GIUNTO	P mm	D2 mm	a mm	b mm	c mm	d mm	e mm	s mm	L mm	caric. rott. mm ²	kg.m
1.1205 K1-02	74552050	74542055	50	25	24	22	46	6,5	36	2,5	11,5	18000	0,035

Disegni CAD disponibili sul sito
www.chiaravalli.com

Quantità, disponibilità e prezzi
con B2B Chiaravalli



CATENE PRODOTTE DA
AZIENDA CERTIFICATA
ISO 9001

Confezioni da 5m

f = superficie resistente

A PERNI FORATI

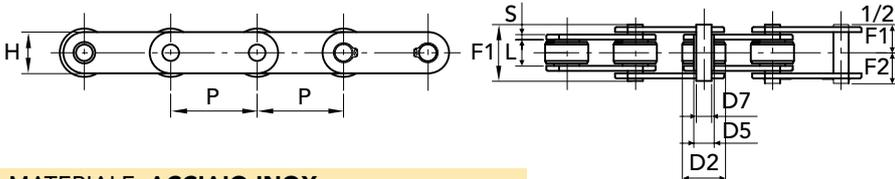

MATERIALE: ACCIAIO INOX

CATENA	CODICE CATENA	CODICE GIUNTO	P mm	L mm	D2 mm	D5 mm	D6 mm	D7 mm	H mm	S mm	F1 mm	F2 mm	caric. rott. N. mm ²	kg.m catena
1,2250	74602500	74602505	50	11,5	25	11	9	6,2	20	2,5	26	14,5	30000	1,8
1,2250 SS	74695400	74695405	50	11,5	25	11	9	6,2	20	2,5	26	14,5	20000	1,8
1,2400	74604000	74604005	50	15	31	17	14	10,2	25	3	31	17,5	35000	3
1,2500	74605000	74605005	50	15	31	17	14	10,2	25	4	35	19,5	40000	3,6
1,2501	74605010	74605015	75	15	31	17	14	10,2	25	4	35	19,5	40000	3,1
1,2502	74605020	74605025	100	15	31	17	14	10,2	25	4	35	19,5	40000	2,6

A PERNI FORATI

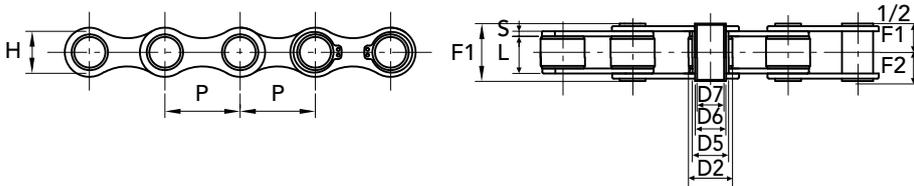

CATENA	CODICE CATENA	CODICE GIUNTO	P mm	L mm	D2 mm	D5 mm	D6 mm	D7 mm	H mm	S mm	F1 mm	F2 mm	caric. rott. N. mm ²	kg.m catena
1.3520 Z	74605200	74605205	35	16	20	17	14	10,2	26	2,5	30	16,7	25000	2,2
1,3520 R	74615200	74615205	35	16	20	17	14	10,2	26	2,5	30	16,7	25000	2,2

A PERNI FORATI ZINCATE

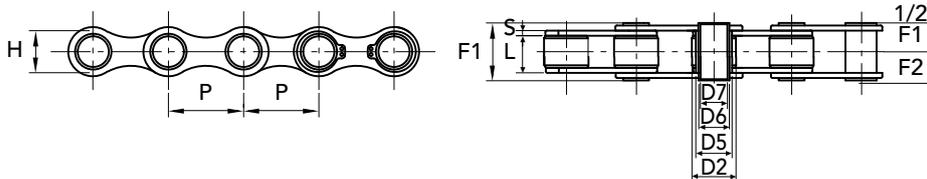

CATENA	CODICE CATENA	CODICE GIUNTO	P mm	L mm	D1 mm	D5 mm	D6 mm	D7 mm	H mm	S mm	F1 mm	F2 mm	caric. rott. N. mm ²	kg.m catena
1.1260 Z	74612600	74612605	41,75	20,5	17	13,8	11	8,3	21,4	3	36	22,7	27	1,5

A PERNI SPORGENTI ZINCATE

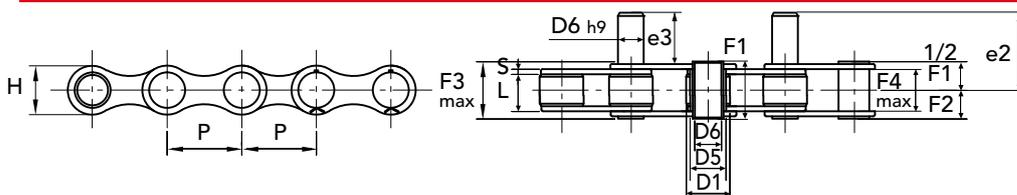

CATENA	CODICE CATENA	CODICE GIUNTO	P mm	D2 mm	a mm	b mm	c mm	d mm	e mm	s mm	L mm	F2 mm	caric. rott. N. mm ²	kg.m attacco			
1.3521 Z	74615210	74615215	35	16	20	13	10	48,5	26	2,5	31	19	35	21	21,5	35000	2,8

Disegni CAD disponibili sul sito
www.chiaravalli.com

Quantità, disponibilità e prezzi
con B2B Chiaravalli

Lunghezza standard m 2 - a richiesta m 3 - 4

Materiale: PE-UHMW

Polietilene ad alto peso molecolare (p.m. oltre 1.000.000).

Colore: verde

Peso specifico g/cm³ 0,945

Coefficiente attrito dinamico 0.2 (P = 0.05 N/mm² - V = 0.6 m/s - T = 40°C)

Temperatura d'impiego: -200°C ÷ 60°C. Per brevi periodi per contatto 80°C.

Dilatazione termica lineare: mm 2 ogni 10°C a partire dalla temperatura ambiente di 20°C.

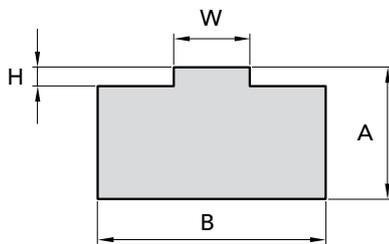
PROFILO "T"

Profilo "T" per catena SEMPLICE	AxB	CODICE CATENA	CATENA	ISO	Dimensione Guide		Peso Kg. m
					H	W	
GCT-06	10 x 15	76109010	3/8"x7/32"	06 B-1	1,5	5,4	0,13
GCT-08	10 x 20	76112010	1/2"x5/16"	08 B-1	2,2	7,4	0,175
	15 x 20	76112015	0,26				
	20 x 20	76112020	0,34				
GCT-10	15 x 20	76115015	5/8"x3/8"	10 B-1	2,6	9,2	0,25
	20 x 20	76115020	0,333				
GCT-12	15 x 25	76119015	3/4"x7/16"	12 B-1	2,4	11,3	0,32
	20 x 25	76119020	0,43				
GCT-16	15 x 40	76125015	1"x17,02 mm	16 B-1	3,5	16,5	0,45
	20 x 40	76125020	0,675				

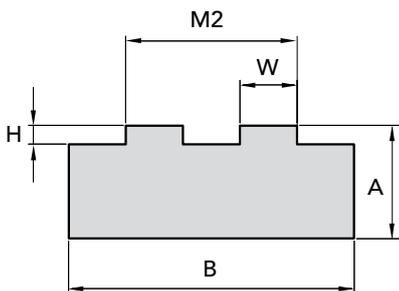
PROFILO "T2"

Profilo "T2" per catena DOPIA	AxB	CODICE CATENA	CATENA	ISO	Dimensione Guide			Peso Kg. m
					H	M2	W	
GC-T2-06	10 x 25	76209010	3/8"x7/32"	06 B-2	1,5	15,74	5,4	0,22
GC-T2-08	10 x 35	76212010	1/2"x5/16"	08 B-2	2,2	21,42	7,4	0,295
	15 x 35	76212015	0,46					
	20 x 35	76212020	0,63					
GC-T2-10	10 x 40	76215010	5/8"x3/8"	10 B-2	2,6	25,79	9,2	0,32
	15 x 40	76215015	0,54					
	20 x 40	76215020	0,77					
GC-T2-12	15 x 45	76219015	3/4"x7/16"	12 B-2	2,4	30,76	11,3	0,62
	20 x 45	76219020	0,845					
GC-T2-16	15 x 65	76225015	1"x17 02 mm	16 B-2	3,5	48,38	16,5	0,86
	20 x 65	76225020	1,185					

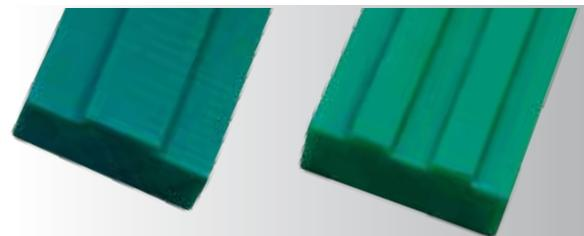

Disegni CAD disponibili sul sito
www.chiaravalli.com

Quantità, disponibilità e prezzi
 con B2B Chiaravalli



Lunghezza standard m 2 - a richiesta m 3 - 4

Materiale: PE-UHMW

Polietilene ad alto peso molecolare (p.m. oltre 1.000.000).

Colore: verde

Peso specifico g/cm³ 0,945

Coefficiente attrito dinamico 0.2 (P = 0.05 N/mm² - V = 0.6 m/s - T = 40°C)

Temperatura d'impiego: -200°C ÷ 60°C. Per brevi periodi per contatto 80°C.

Dilatazione termica lineare: mm 2 ogni 10°C a partire dalla temperatura ambiente di 20°C.

PROFILO "T3"

Profilo "T3" per catena TRIPLA	Ax B	CODICE CATENA	CATENA	ISO	Dimensione Guide			Peso Kg. m
					H	M3	W	
GC-T3-06	10 x 35	76309010	3/8"x7/32"	06 B-3	1,5	25,88	5,4	0,77
GC-T3-08	10 x 45	76312010	1/2"x5/16"	08 B-3	2,2	35,24	7,4	0,82
	15 x 45	76312015						1,045
	20 x 45	76312020						1,27
GC-T3-10	10 x 55	76315010	5/8"x3/8"	10 B-3	2,6	42,38	9,2	0,85
	15 x 55	76315015						1,125
	20 x 55	76315020						1,4
GC-T3-12	15 x 60	76319015	3/4"x7/16"	12 B-3	2,4	50,22	11,3	0,855
	20 x 60	76319020						1,155

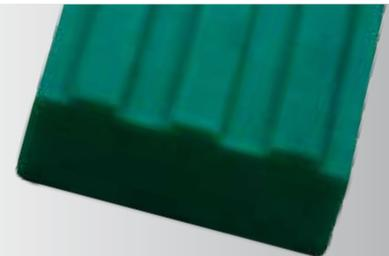
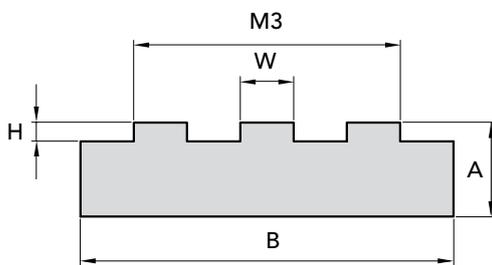

Lunghezza standard m 2 - a richiesta m 3 - 4

Materiale: PE-UHMW

Polietilene ad alto peso molecolare (p.m. oltre 1.000.000).

Colore: verde

Peso specifico g/cm³ 0,945

Coefficiente attrito dinamico 0.2 (P = 0.05 N/mm² - V = 0.6 m/s - T = 40°C)

Temperatura d'impiego: -200°C ÷ 60°C. Per brevi periodi per contatto 80°C.

Dilatazione termica lineare: mm 2 ogni 10°C a partire dalla temperatura ambiente di 20°C.

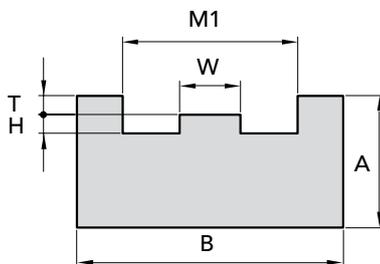
PROFILO "E"

Profilo "E" per catena SEMPLICE	Ax B	CODICE CATENA	CATENA	ISO	Dimensione Guide				Peso Kg. m
					H	M1	W	T	
GC-E-06	10 x 25	76409010	3/8"x7/32"	06 B-1	1,5	15	5,4	4,35	0,188
GC-E-08	15 x 30	76412015	1/2"x5/16"	08 B-1	2,2	20	7,4	7,2	0,352
GC-E-10	20 x 33	76415015	5/8"x3/8"	10 B-1	2,6	23	9,2	9,5	0,394
GC-E-12	20 x 38	76419020	3/4"x7/16"	12 B-1	2,4	28	11,3	11,11	0,564
GC-E-16	25 x 51	76425025	1"x17,02mm	16 B-1	3,5	41	16,5	16,48	0,83

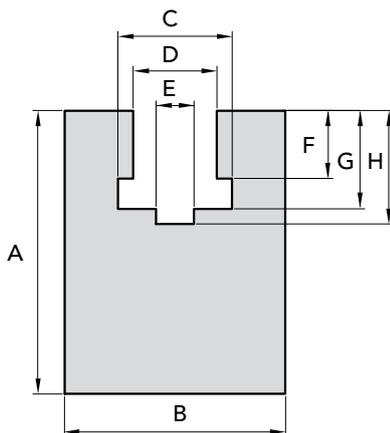
PROFILO "K"

Profilo "K" per catena SEMPLICE	Ax B	CODICE CATENA	CATENA	ISO	Dimensione Guide						Peso Kg. m
					H	D	E	F	G	C	
GC-K-06	25 x 20	76509025	3/8"x7/32"	06 B-1	10	6,8	4	5,6	8,7	9,3	0,43
GC-K-08	30 x 24	76512030	1/2"x5/16"	08 B-1	12,7	9	5	7,4	11,5	12,8	0,55
GC-K-10	35 x 30	76515035	5/8"x3/8"	10 B-1	14,8	10,7	6	9,3	13,5	15,4	0,83
GC-K-12	35 x 40	76519035	3/4"x7/16"	12 B-1	17,5	12,7	7	11,3	15,9	16,9	1,1
GC-K-16	45 x 40	76525045	1"x17,02	16 B-1	26,8	16,5	9	16,6	25,7	24,4	1,22

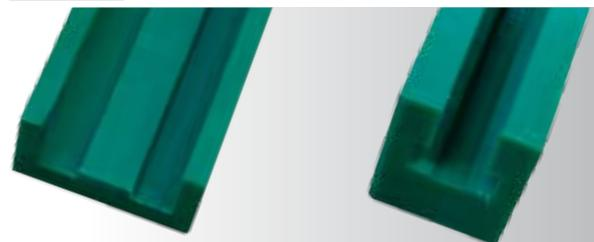

Disegni CAD disponibili sul sito
www.chiaravalli.com

Quantità, disponibilità e prezzi
 con B2B Chiaravalli

**Lunghezza standard m 2 - a richiesta m 3 - 4**

Materiale: PE-UHMW

Polietilene ad alto peso molecolare (p.m. oltre 1.000.000).

Colore: verde

Peso specifico g/cm³ 0,945Coefficiente attrito dinamico 0.2 (P = 0.05 N/mm² - V = 0.6 m/s - T = 40°C)

Temperatura d'impiego: -200°C ÷ 60°C. Per brevi periodi per contatto 80°C.

Dilatazione termica lineare: mm 2 ogni 10°C a partire dalla temperatura ambiente di 20°C.

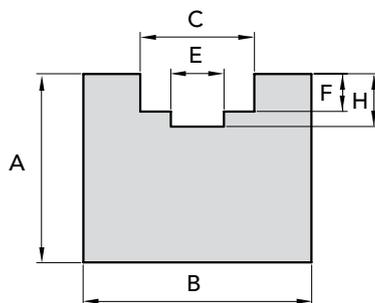
PROFILO "U"

Profilo "U" per catena SEMPLICE	Ax B	CODICE			Dimensione Guide				Peso Kg. m
		CATENA	CATENA	ISO	H	M1	W	T	
GC-U-06	15 x 20	76609015	3/8"x7/32"	06 B-1	4,2	4	2,8	9,2	0,26
GC-U-08	15 x 25	76612015	1/2"x5/16"	08 B-1	4,8	5	3,5	12,7	0,31
GC-U-10	15 x 25	76615015	5/8"x3/8"	10 B-1	5,1	6	3,6	15,2	0,3
GC-U-12	20 x 25	76619020	3/4"x7/16"	12 B-1	5,7	7	3,9	16,7	0,4

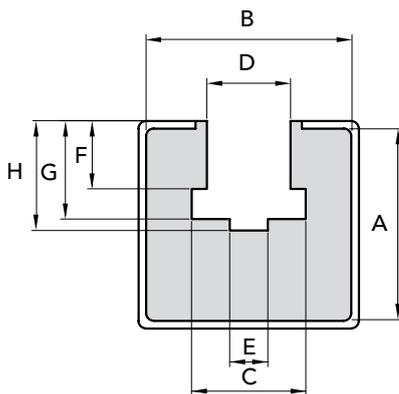
PROFILO "KG"

Profilo "KG" per catena SEMPLICE	Ax B	CODICE			Supp. met.	Dimensione Guide							Peso Kg. m
		CATENA	CATENA	ISO		H	D	E	F	G	C		
GC-KG-08	22,5 x 27	76712022	1/2"x5/16"	08 B-1	C10	13	8,7	5	7,4	11,5	12,8	1,295	
GC-KG-10	22,5 x 27	76715022	5/8"x3/8"	10 B-1	C10	14,9	10,7	6	9,3	13,5	15,4	1,285	
GC-KG-12	22,5 x 27	76719022	3/4"x7/16"	12 B-1	C10	17,5	12,3	7	11,3	15,9	16,9	1,275	

Guida catena predisposta per supporto metallico

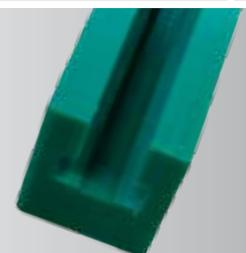



Lunghezza standard m 2 - a richiesta m 3 - 4

Materiale: PE-UHMW

Polietilene ad alto peso molecolare (p.m. oltre 1.000.000).

Colore: verde

Peso specifico g/cm³ 0,945

Coefficiente attrito dinamico 0.2 (P = 0.05 N/mm² - V = 0.6 m/s - T = 40°C)

Temperatura d'impiego: -200°C ÷ 60°C. Per brevi periodi per contatto 80°C.

Dilatazione termica lineare: mm 2 ogni 10°C a partire dalla temperatura ambiente di 20°C.

PROFILO "CT"

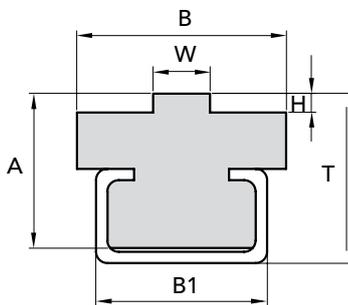

Guida catena predisposta per supporto metallico

Profilo "CT" per catena SEMPLICE	AxB	CODICE CATENA	CATENA	Supp. ISO met.	Dimensione Guide H T W B2	Peso Kg. m
GC-CT-08	15 x 20	76812015	1/2"x5/16"	08 B-1 C3	22,2 17 7,4 20	0,82
GC-CT-10	15 x 20	76815015	5/8"x3/8"	10 B-1 C3	2,6 17 9,2 20	0,83
GC-CT-12	15 x 20	76819015	3/4"x7/16"	12 B-1 C3	2,4 17 11,3 20	0,84
GC-CT-16	15 x 28	76825015	1"x17,02	16 B-1 C5	3,5 18 16,5 28	1,24

PROFILO "CT2"

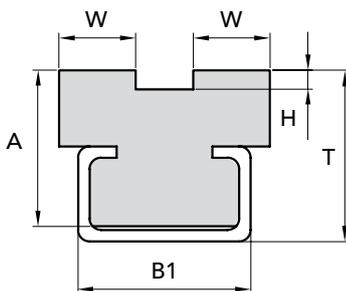

Guida catena predisposta per supporto metallico

Profilo "CT2" per catena SEMPLICE	AxB	CODICE CATENA	CATENA	Supp. ISO met.	Dimensione Guide H T W B2	Peso Kg. m
GC-CT2-06	15 x 15,7	76909015	3/8"x7/32"	06 B-2 C3	1,5 17 5,4 20	0,74
GC-CT2-08	15 x 21,4	76912015	1/2"x5/16"	08 B-2 C3	2,2 17 7,4 20	0,84
GC-CT2-10	15 x 25,9	76915015	5/8"x3/8"	10 B-2 C5	2,6 19 9,2 28	0,85
GC-CT2-12	15 x 30,7	76919015	3/4"x7/16"	12 B-2 C5	2,4 19 11,3 28	1,25
GC-CT2-16	20 x 48,3	76925020	1"x17,02	16 B-2 C9	3,5 27 16,5 38	2,15

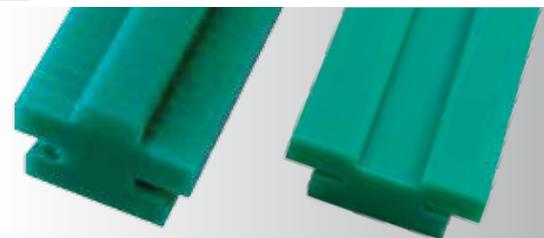



Materiale: FE ZINCATO O INOX AISI 304

A richiesta si eseguono profili su disegno del cliente.

LAMIERA ZINCATA

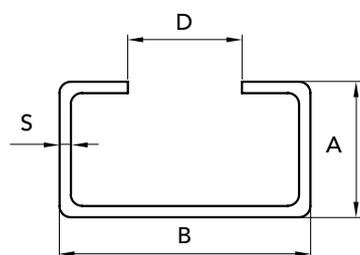

SUPPORTI METALLICI	CODICE CATENA	lunghezza standard m.	Dimensione Guide				Peso Kg. m	
			A	B	D	S		
AxB								
C3	10 x 20	76003010	2	10	20	10	1,3	0,48
C5	12 x 28	76005012	2	12	28	14	1,5	0,85
C9	18 x 38	76009018	2	18	38	22	1,5	1,5
C10	24 x 30	76010024	2	24	30	20	1,5	0,95

LAMIERA IN ACCIAIO INOX AISI 304

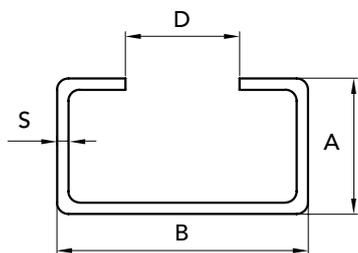

SUPPORTI METALLICI	CODICE CATENA	lunghezza standard m.	Dimensione Guide				Peso Kg. m	
			A	B	D	S		
AxB								
C3	10 x 20	76003310	2	10	20	10	1,3	0,48
C5	12 x 28	76005312	2	12	28	14	1,5	0,85
C9	18 x 38	76009318	2	18	38	22	1,5	1,5
C10	24 x 30	76010324	2	24	30	20	1,5	0,95

Disegni CAD disponibili sul sito www.chiaravalli.com

Quantità, disponibilità e prezzi con B2B Chiaravalli

